

Operating Manual

A 4505B Lockdown Timer

Optional Accessories

- A 2064 Lockdown/Fire/Cancel Remote Wall Plate (Hard Wired)**
- A 2069 Lockdown/Fire/Bell/Cancel Remote Wall Plate (Hard Wired)**
- A 4599 Lockdown/Fire/Bell/Cancel Remote Wall Plate (U/UTP Cat5)**
- A 4599V Lockdown/Fire/Bell/Cancel Remote Wall Plate (U/UTP Cat5)**

Optional Wall Plates

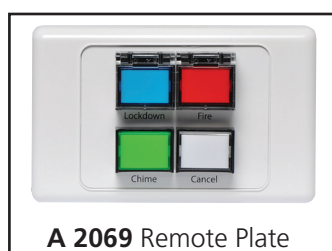
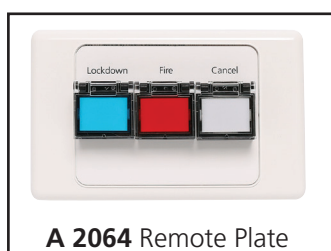

User manual revision number: 1.1 12/08/2021

Distributed by Altronic Distributors Pty. Ltd.

Phone: 1300 780 999 Fax: 1300 790 999 Internet: www.altronic.com.au

IMPORTANT NOTE:

Please read these instructions carefully from front to back prior to installation. They include important setup instructions. Failure to follow these instructions may prevent the unit from working as designed.



REDBACK is a registered trademark of Altronic Distributors Pty Ltd

Since 1976 Redback amplifiers have been manufactured in Perth, Western Australia by Altronics. With over 40 years experience in the commercial audio industry, we offer consultants, installers and end users reliable products of high build quality with local product support. We believe there is significant added value for customers when purchasing an Australian made Redback amplifier or PA product

Australian Made Status

All Redback house products made by Altronics will now be sporting the official Australian Made logo. Since starting manufacturing of commercial audio equipment in the mid 70's we have always taken pride in producing a quality local product.

The new adoption of the Australian Made logo will help us get the word out to local and export markets that our products carry the official compliance seal of the Australian Made campaign. We have always pushed our 'local is better' line in all of our marketing efforts, it's always an added boost when you are backed up by a widely recognised and respected icon.

Industry leading 10 year warranty.

There's a reason we have the industry leading DECADE warranty. It's because of a long tried and tested history of bulletproof reliability. We've heard PA contractors tell us they still see the original Redford amplifier still in service in schools - that's over 40 years of operation - and still going strong!

CONTENTS

1.0 Overview	Page
1.1 Introduction	4
1.2 Features	4
1.3 What's in the box	4
1.4 Front panel guide	5
1.5 Rear panel connections	6
2.0 Setup	
2.1 Initial Setup	8
2.2 Lockdown, Fire and Bell Switches	9
2.3 Programming the timing events using the front buttons	10
2.4 Programming the timing events using the supplied PC software	12
2.5 Setting the current time	16
2.6 Deleting a programmed time	17
2.7 Reseting all programmed times	17
2.8 Audio Connections	18
2.9 Voice-Over Messages	18
2.10 DIP Switch settings	18
2.11 24V DC Output Connections	19
3.0 Remote Wall Plates	
3.1 A 2064 and A 2069 Remote Plates	19
3.2 A 4599 and A 4599V Remote Plate	21
4.0 Troubleshooting	
4.1 Symptoms and Remedies	22
4.2 RJ45 Cabling Configuration	23
5.0 Firmware Update	23
6.0 Specifications & Warranty	24

1.0 OVERVIEW

1.1 INTRODUCTION

The Redback® A 4505B is a weekly timer and Lockdown and Fire Alarm controller all housed in a convenient 1RU rack mount chassis. A total of 50 "event" switching times are available through the timing functions. Each event can be set to turn on any single day of the week or on multiple days, from 1 sec up to 24 hours. When a timing event is activated, an MP3 audio file will be played and output through the dual RCA line level output.

There are fourteen MP3 playback options for the timing events, which include the Bell, Prebell, Music and folders 5-15. A Micro SD card which is supplied, houses all the MP3 files to be played as well as storing all the timing events (Note: The audio files must be in MP3 format). The timing events can be programmed via the unit's front buttons which is a bit cumbersome, or they can be programmed with the supplied PC software (also available as a download from www.altronics.com.au).

The timing events can also be programmed to only trigger the Bell 24V out (and in turn the common 24V Out), with no audio output. This is activated by setting the output to the "relay" option in the programming setup.

The Lockdown/Fire controller is designed around industry standard building emergency Lockdown/Fire requirements. When connected to a paging system amplifier, building occupants can be alerted and/or evacuated in the event of an emergency e.g. fire, gas leak, bomb scare, earthquake. Lockdown & Fire switches on the front of the unit are fitted with safety covers to prevent accidental operation.

The Lockdown, Fire and Bell tones and the cancel function are triggered by the front switches, or by the rear terminal contacts for remote activation. Switched 24V DC Out connections are provided for Bell, Lockdown, Fire or a Common out. These contacts are for connection of override relays in remote volume controls, warning strobes, bells etc.

The Lockdown and Fire tones are stored on a Micro SD card (Emergency Tones which conform to AS1670.4 are supplied) to allow the user to provide any tones they require (Note: The audio files must be in MP3 format).

The Fire mode has a voice over option for the playback of a Fire message after every playback of the Fire tone. The voice over message is also stored on the SD card and is DIP switch enabled.

The Lockdown mode has a voice over option for the playback of a Lockdown message after every playback of the Lockdown tone. The voice over message is also stored on the SD card and is DIP switch enabled.

1.2 FEATURES

- MP3 audio format for Bell, Prebell and Music timing outputs
- MP3 audio format Emergency Tones conform to AS 1670.4 (supplied)
- Random play of MP3 files for Prebell and Music triggers
- Easy PC based timing event setup
- Local push button operation of Lockdown, Fire and Bell
- Remote triggering of Lockdown, Fire and Bell
- MP3 audio format Voice over message (Available in the Lockdown and the Fire cycle)
- Switched 24VDC output for Bell, Lockdown or Fire mode
- Pluggable screw terminal connections
- Auxiliary level output
- Battery backup of current time
- 24V DC operation
- Standard 1U 19" rack mount case
- Suitable for any amplifier with an auxiliary input
- 10 Year Warranty
- Australian Designed and Manufactured

1.3 WHAT'S IN THE BOX

Redback® A 4505B Lockdown Timer
24V 2A DC Plugpack
Instruction Booklet

1.4 FRONT PANEL GUIDE

Fig 1.4A shows the layout of the A 4505B front panel.

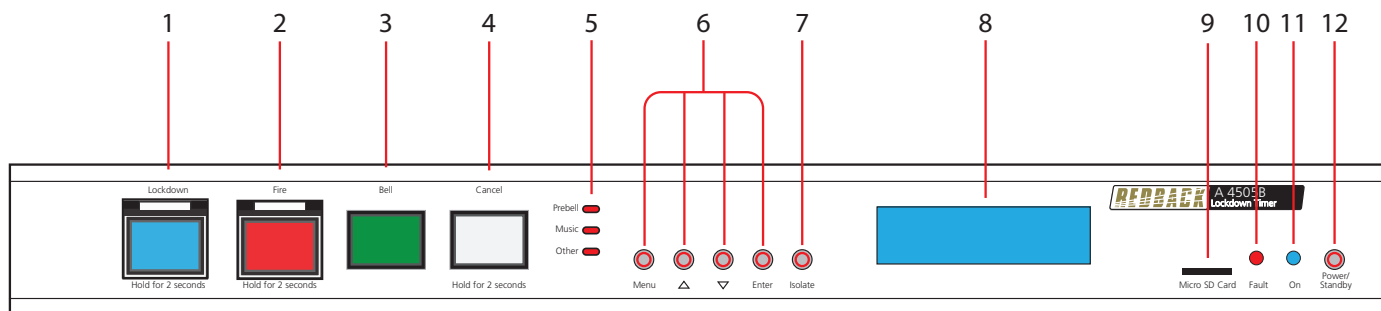

Fig 1.4A

1 Lockdown Tone Activation Switch

This switch is used to activate the Lockdown tone. It may need to be pressed for up to 2 seconds to activate.

2 Fire Tone Activation Switch

This switch is used to activate the Fire tone. It may need to be pressed for up to 2 seconds to activate.

3 Bell Tone Activation Switch

This switch is used to activate the Bell tone.

4 Cancel Tone Activation Switch

This switch is used to cancel the Lockdown, Fire or bell tone. It may need to be pressed for up to 2 seconds to activate.

5 Status LEDs

Prebell LED - This LED indicates when the Prebell is active.

Music LED - This LED indicates when an MP3 from the Music Folder is active.

Other LED - This LED indicates when an MP3 from one of the Music Folders 5 - 15 is active.

6 Menu and Navigation Switches

These switches are used to navigate the menu functions of the unit.

7 Isolate Switch

This switch is used to isolate the timing functions of the unit. Note: When this is enabled the Alert, Evac and Chime buttons and remote triggers will still function.

8 LCD Display

This displays the current time and other timing functions.

9 Micro SD Card

This is used to store the MP3 audio files for the Prebell, Bell, Alert, Evac, Music and MP3 folders 5-15 playback. It also stores the timing events for the timer. (More details in section 2.1).

NOTE: All folders except the "Prebell" and "Music" folders must have only one MP3 file installed. The "Prebell" and "Music" folders can have unlimited MP3 files (depending on available storage) and will then randomly play the MP3 files in the folder each time the corresponding prebell or music contact is triggered.

Note : MP3 files should have the following specifications for optimum performance.

128kbps, 44.1kHz, 32bit, VBR or CBR, Stereo (even better as mono).

10 Fault Indicator

This LED indicates that the unit has a fault.

11 On Indicator

This LED indicates the unit is ON.

12 Standby Switch

When the unit is in standby mode this switch will illuminate. Press this button to switch the unit ON. Once the unit is ON the On indicator will illuminate. Press this switch again to put the unit back in standby mode.

Redback® A 4505B Lockdown Timer

1.5 REAR PANEL CONNECTIONS

Fig 1.5A shows the layout of the A 4505B rear panel.

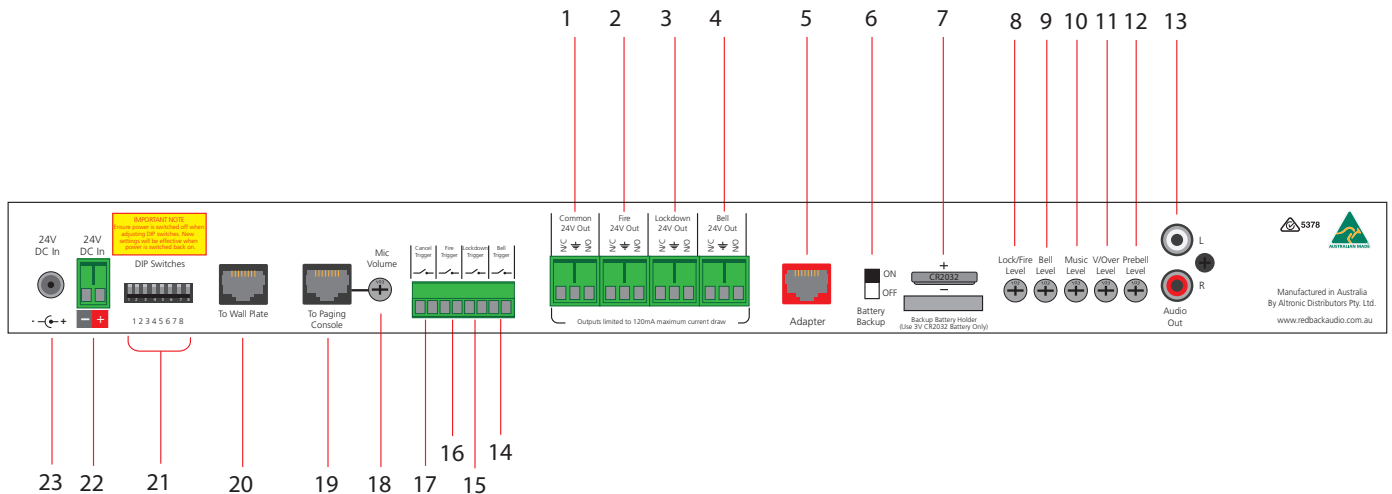

Fig 1.5A

- 1 Common 24V Out**

This is a common 24V DC output which is activated when any of the Prebell, Bell, Music, Lockdown or Fire tones are activated. The terminals provided can be used for "Normal" or "Failsafe" modes (see section 2.10 for more details).
- 2 Fire 24V Out**

This is a 24V DC output which is activated when the Fire tone is activated. The terminals provided can be used for "Normal" or "Failsafe" modes (see section 2.10 for more details).
- 3 Lockdown 24V Out**

This is a 24V DC output which is activated when the Lockdown tone is activated. The terminals provided can be used for "Normal" or "Failsafe" modes (see section 2.10 for more details).
- 4 Bell 24V Out**

This is a 24V DC output which is activated when the Bell tone or relay only (No MP3 option) is activated. The terminals provided can be used for "Normal" or "Failsafe" modes (see section 2.10 for more details).
- 5 RJ45 Adapter**

This RJ45 port is for future connection of Redback devices.
- 6 Backup Battery Switch**

Use this switch to activate the backup battery. (Note: The backup battery only backs up the current time).
- 7 Backup Battery**

Replace this battery with a 3V CR2032 only. Remove by pulling the battery.
Note: The positive side of the battery faces upward.
- 8 Lockdown/Fire Volume**

Adjust this trimpot to adjust the Alert and Evacuation tones playback volume.
- 9 Bell Volume**

Adjust this trimpot to adjust the Bell playback volume.
- 10 Music Volume**

Adjust this trimpot to adjust the Music playback volume.
- 11 Voice-over Volume**

Adjust this trimpot to adjust the message voice-over playback volume.
- 12 PreBell Volume**

Adjust this trimpot to adjust the PreBell playback volume.

- 13 Audio Out RCA Connectors**
Connect these outputs to the input of the background music amplifier.
- 14 Bell Contact**
These contacts are for remote triggering of the Bell tone. These could be triggered by a remote switch or other closing contact.
- 15 Lockdown Contact**
These contacts are for remote triggering of the Lockdown tone. These could be triggered by a remote switch or other closing contact.
- 16 Fire Contact**
These contacts are for remote triggering of the Fire tone. These could be triggered by a remote switch or other closing contact.
- 17 Cancel Contact**
These contacts are for remote triggering of the cancel function. These could be triggered by a remote switch or other closing contact.
- 18 Mic Volume**
Adjust this trimpot to adjust the Paging Microphone volume (Microphone currently not available).
- 19 RJ45 interface**
This RJ45 port is for connection of a microphone paging console (currently not available).
- 20 RJ45 interface**
This RJ45 port is for connection to the A 4599 or A 4599V wall plates.
- 21 Dip Switches**
These are used to select various options. Refer to DIP Switch Settings section.
- 22 24V DC Input (Backup)**
Connects to a 24V DC backup supply with at least 1 amp current capacity. (Please observe the polarity)
- 23 24V DC input**
Connects to a 24V DC Plugpack with 2.1mm Jack.

2.0 SETUP GUIDE

2.1 INITIAL SETUP

For the unit to function correctly, the supplied SD card must be installed and have MP3 files in each of the Lockdown, Fire, Bell, Prebell and Music folders as shown in Fig 2.1.

NOTE: The unit will display an MP3 error message on the screen if any of these folders on the SD card are left empty. I.e. the Lockdown, Bell, Fire, Music and Prebell folders must all have an MP3 file inside.

The Micro SD card should have the following folders already installed “Lockdown, Bell, Fire, Music, Prebell, Voice and 5-15”. If these folders don’t exist they will have to be created.

Inside each of these folders (except the 5-15 folders) there will be a sample MP3 audio file. A library of sample MP3 files is supplied (in the #LIBRARY# folder).

NOTE: All folders except the “Prebell” and “Music” folders must have only one MP3 file installed. The “Prebell” and “Music” folders can have unlimited MP3 files (depending on available storage) and will then randomly play the MP3 files in the folder each time the corresponding prebell or music contact is triggered or time activated.

In order to install MP3 files onto the Micro SD card, or move the sample MP3’s to their relevant folders, the Micro SD card will need to be connected to a PC. You will need a PC or laptop equipped with a Micro SD card reader to do this. If a Micro SD slot is not available then the Altronics D 0371B USB Memory Card Reader or similar would be suitable (not supplied).

You will first need to remove power from the A 4505B and then remove the Micro SD card from the front of the unit. To remove the Micro SD card push the card in and it will eject itself.

Step by step guide to install an MP3 into it’s associated folder with a Windows based PC.

Step 1: Make sure the PC is on and card reader connected and correctly installed. Then insert the Micro SD card into the reader.

Step 2: Go to “My Computer” or “This PC” and open the Micro SD card which is usually marked “Removable disk”. In this case it is named “Removable disk (O:)”. Select the removable disk and then you should get a window that looks like figure 2.1.

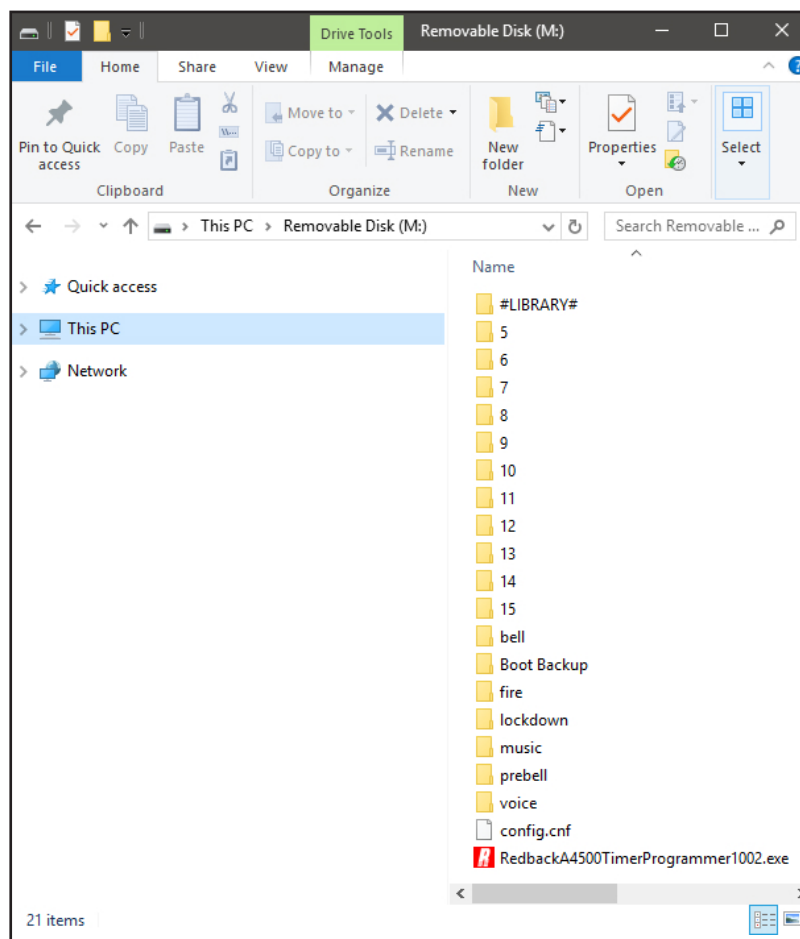

Fig 2.1

Step 3: Open the folder to change, in our example the “bell” folder, and you should get a window that looks like figure 2.2.

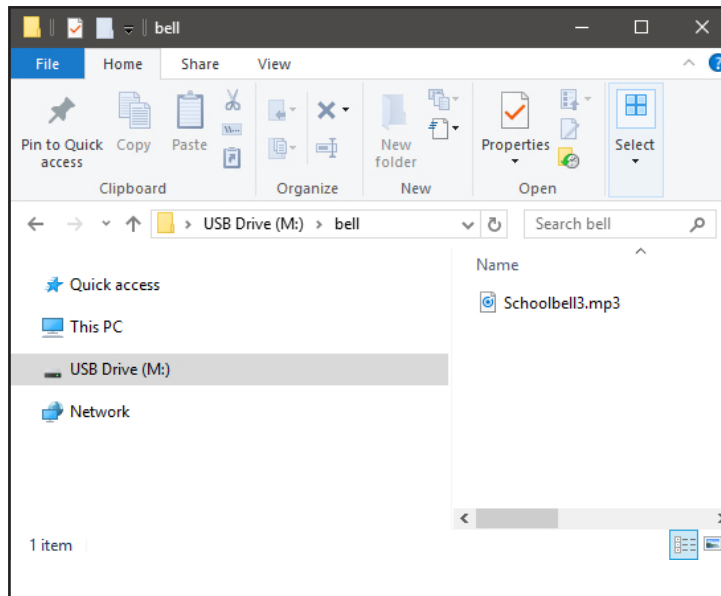

Fig 2.2

Step 4: You should see an MP3 file “Schoolbell.mp3”.

This MP3 file needs to be deleted and replaced by the MP3 file you want to play when you activate the bell. The MP3 file name is not important only that there is one MP3 file in the “bell” folder. Make sure you delete the old MP3!

Note 1: MP3 files should have the following specifications for optimum performance.

128kbps, 44.1kHz, 32bit, VBR or CBR, Stereo (even better as mono).

Note 2: All folders except the “Prebell” and “Music” folders must have only one MP3 file installed. The “Prebell” and “Music” folders can have unlimited MP3 files (depending on available storage).

Note that the new MP3 file cannot be “Read only”. To check this right click on the MP3 file and scroll down and select Properties, you will get a window that looks like figure 2.3. Make sure the “Read Only” box has no tick in it.

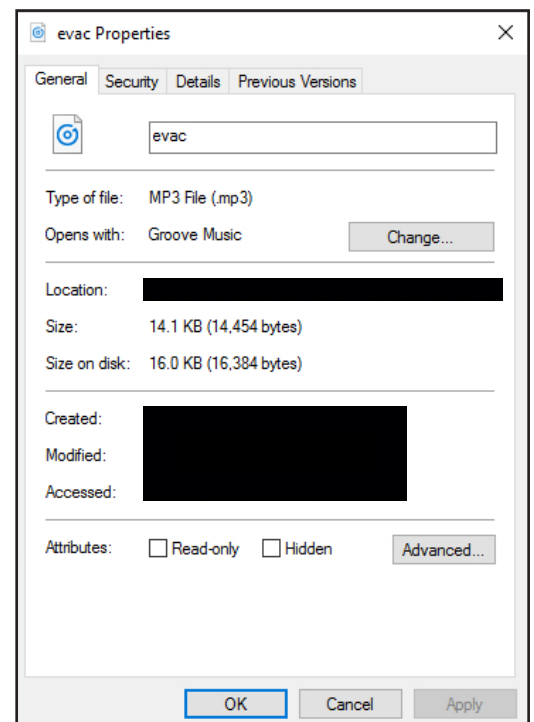

Fig 2.3

Repeat these steps for the other folders.

The new MP3's are now installed on the SD card, and the card can be removed from the PC following windows safe card removal procedures. Make sure the A 4505B is OFF and insert the SD card into the SD card slot ; it will click when fully inserted. The A 4505B can now be switched back On. If all the MP3 files are OK then the unit will display the time screen. If an MP3 error message is displayed, there is a problem with one or more of the MP3 files.

2.2 LOCKDOWN, FIRE AND BELL SWITCHES

The Lockdown, Fire and Bell switches on the front of the unit all work in momentary mode. ie. The Lockdown tone will continue to sound after the Lockdown switch is momentarily pressed and the Fire tone will continue to sound after the Fire switch is momentarily pressed. There is an automatic Lockdown to Fire switch-over option associated with the front panel switches (refer to section 2.8).

Note 1: The tone that is being sounded (ie Lockdown, Fire, bell) will be indicated by the illumination of the relevant front panel indicator.

Note 2: To cancel a tone either use the remote cancel contacts or the front cancel button. Note the cancel button will need to be depressed for 2 seconds. This is to prevent accidental cancelling of a tone.

The Lockdown, Fire and Bell tones are stored on the supplied SD card. Separate folders are supplied on the SD card for each tone. It is up to the user to provide the MP3 files (they must be in MP3 format) for each of the tones. A library of sample MP3 files is supplied (in the #LIBRARY# folder). See section 2.1 for more details.

NOTE: The unit will display an MP3 error message on the screen if any of the folders on the SD card are left empty. I.e. the Lockdown, Bell, Fire, Music, Prebell and Voice folders must all have an MP3 file inside.

Once these Lockdown, Fire and Bell outputs are activated, the corresponding 24V switched outputs will become active (refer to section 2.6 for more details)

2.3 PROGRAMMING THE TIMING EVENTS USING THE FRONT BUTTONS

If the unit starts up correctly and no error messages are displayed, the model number will be displayed briefly before the current time is shown. See Fig 2.4.



Fig 2.4

If this screen doesn't appear and instead an MP3 error message is displayed, then either the SD card is not inserted correctly or there is a missing MP3 file.

NOTE: The unit will display an MP3 error message on the screen if any of the folders on the SD card are left empty. I.e. the Lockdown, Bell, Fire, Music, Prebell and Voice folders must all have an MP3 file inside.

The main screen (Current Time Screen) shown in Fig 2.5 displays the current time and day, and the next programmed event.

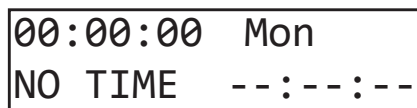

Fig 2.5

When this screen is displayed the unit is running in "AUTO MODE" and therefore all outputs will work as programmed. However if the unit is in any of the sub menu's (Menu Mode) the unit will no longer respond to any event that has been programmed to occur. On exiting the menu, the timer will check all programmed events and update the status of the output zones.

In order to set up the timer, the station (or event) times will need to be programmed. This can be achieved by using the buttons on the front of the unit or via the PC software (supplied on the SD card) see section 2.4 for more details.

PROGRAMMING THE TIMING EVENTS USING THE FRONT BUTTONS

There are five buttons on the front of the timer which are used to program the unit and navigate the various menus.

Press the "Menu" button on the front of the timer. The unit is now in "Menu Mode" and the screen should display the "Times Adjust" Screen. This is the first of 5 sub menu screens which are navigated by pressing the up and down buttons as shown in Fig 2.6. Pressing the Menu button again will exit the menu structure and return the user to the Main Screen.

SPECIAL NOTE ABOUT "AUTO MODE" OPERATION
If the timer is not displaying the main clock screen, where the time is changing, the unit is not running in "Auto Mode". This means it will not be checking any of the programmed events and hence will not activate any outputs automatically.
Essentially this means that as soon as the Menu button is pressed the unit is no longer in "Auto Mode".
Make sure to return to the main screen by exiting all menu's when not making changes.

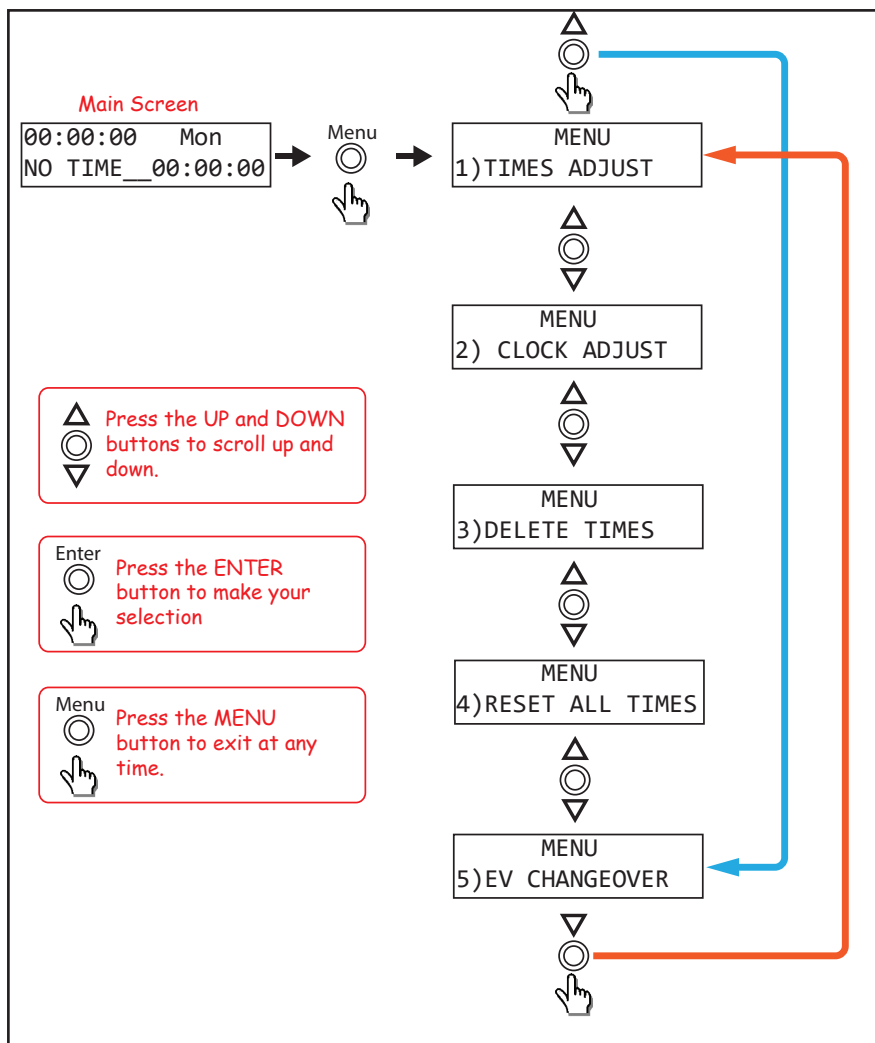

Select the desired sub menu by pressing the "Enter" button.

There are 4 options to choose from.

- 1) Times Adjust
- 2) Clock Adjust
- 3) Delete Times
- 4) Reset All Times
- 5) EV Changeover

Fig 2.6

2.3.1 Times Adjust

After selecting this option, the screen as shown in Fig 2.7 should appear.

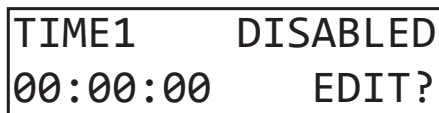

Fig 2.7

This option allows the user to enter the Station (Event) information which includes the event "Turn on time", "Period" and "Output MP3".

The top left text is the time event number. Up to 50 events can be programmed into the A 4505B. Pressing the "up" and "down" buttons at this stage will move up and down through the events 1- 50. The top right text indicates that TIME1 (Event1) is currently disabled. The bottom left text refers to the time this event will happen (i.e. the "Start" Time).

Press the "Enter" button to edit this event, or press the "Menu" button to exit.

Pressing the Enter button will take you to the "Editing Time" screen (Refer to fig 2.8). This is where the event "Start" time is entered. The cursor will be positioned over the hour section of the time. Use the up and down buttons to change the

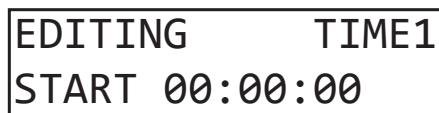

Fig 2.8

hour and then press the "Enter Button" to confirm the hour. The cursor will move to the minutes section of the time. Use the up and down buttons to change the minutes and then repeat the process again for the seconds. Once the seconds have been updated the screen will change to the "Period" set screen (Refer to fig 2.9) . This is where the length of time the event should occur, is recorded.

EDITING	TIME1
PERIOD	00:00:00

Fig 2.9

Once again, use the up and down buttons to set the hour, minutes and seconds and press enter when finished. Once the period has been set, the desired output MP3 for this event is to be set using the MP3 output screen (See fig 2.10).

EDITING	TIME1
MP3 - - - -	PREBELL

Fig 2.10

The MP3 output defaults to Prebell. Scroll through the other options by using the up and down buttons. The MP3 output can be set to Prebell, Bell, Music, No MP3 or the output can be disabled. These MP3 outputs correspond to the MP3 audio files located in the Prebell, Bell and Music folders on the SD card.

RELAY OUTPUT CONFIGURATION

The 24V switched outputs associated with the Prebell, Bell and Music folders are as follows.

When the Bell output is active the Bell 24V output and Common 24V output will become active.

When the Prebell and Music outputs are active the the Common 24V output only will become active.

The NO MP3 option will activate the Bell and Common 24V output, but no audio file will be played.

Once the desired output for the event has been set, press the enter button to move to the next screen (See fig 2.11). This is where the days of the week this event will occur are entered. The top right line of text refers to the days of the week, Monday through to Sunday. The line of text below this sets each day "ON" or "OFF". Use the up and down buttons to set the day to Y for "ON" and N for "OFF".

DAYS -	MTWTFSS
	NNNNNNN

Fig 2.11

Once the days of the week are set, press the enter button to confirm and be returned to the main menu. Repeat this process for any other events to be programmed.

This process of entering the events can be quite time consuming. An easier method of entering this information is by using the supplied PC software which is provided on the SD card (see section 2.4).

2.4 PROGRAMMING THE TIMING EVENTS USING THE SUPPLIED PC SOFTWARE

The PC software is provided on the units' SD Card and is called "RedbackA4500TimerProgrammer" or similar.

This software can be used to program the Redback® A 4500B or Redback® A 4505B.

Note: Updated versions are available for download from www.altronics.com.au or redbackaudio.com.au.

In order to access the program, the SD card will need to be connected to a PC. You will need a PC or laptop equipped with an SD card reader to do this. If an SD slot is not available then the Altronics D 0371A USB Memory Card Reader or similar would be suitable (not supplied).

You will first need to remove power from the A 4505B and then remove the SD card from the rear of the unit.

To remove the SD card push the card in and it will eject itself.

Make sure the PC is on and card reader connected and correctly installed. Then insert the SD card into the reader.

Go to "My Computer" or "This PC" and open the SD card which is usually marked "Removable disk". In this case it is named "Removable disk (M:)". Select the removable disk and then you should get a window that looks like figure 2.12.

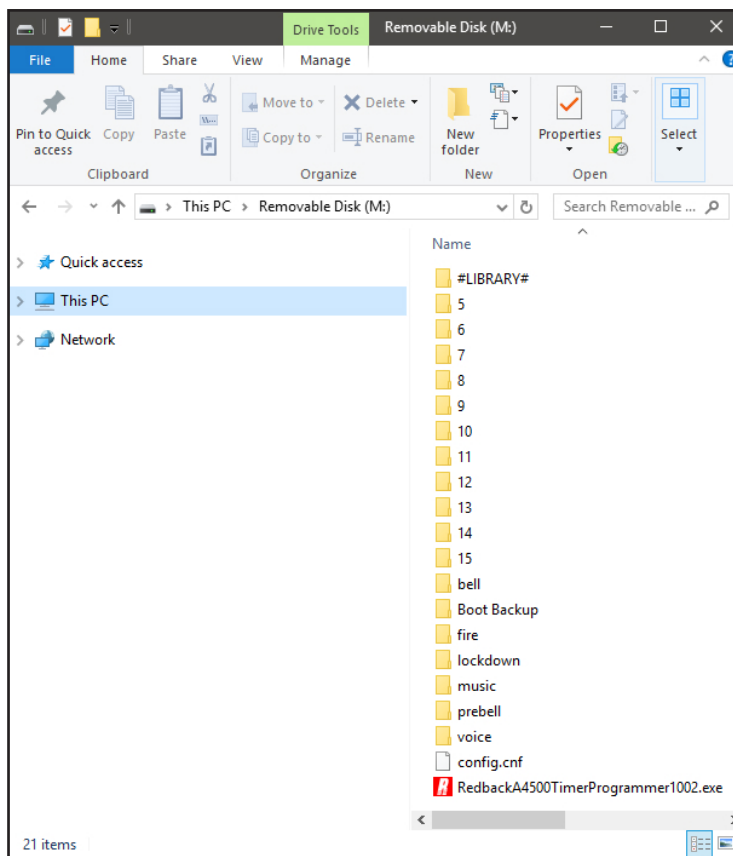

Fig 2.12

The program can be run on the SD card or it could be copied to the PC desktop or another folder and run from there. Double click on the .exe file - RedbackA4500TimerProgrammer or similar. The programming screen should appear as shown in fig 2.13.

If the program doesn't run then the .NET Framework might need to be updated on your PC. This must be updated to the .NET Framework 4, available on the microsoft website.

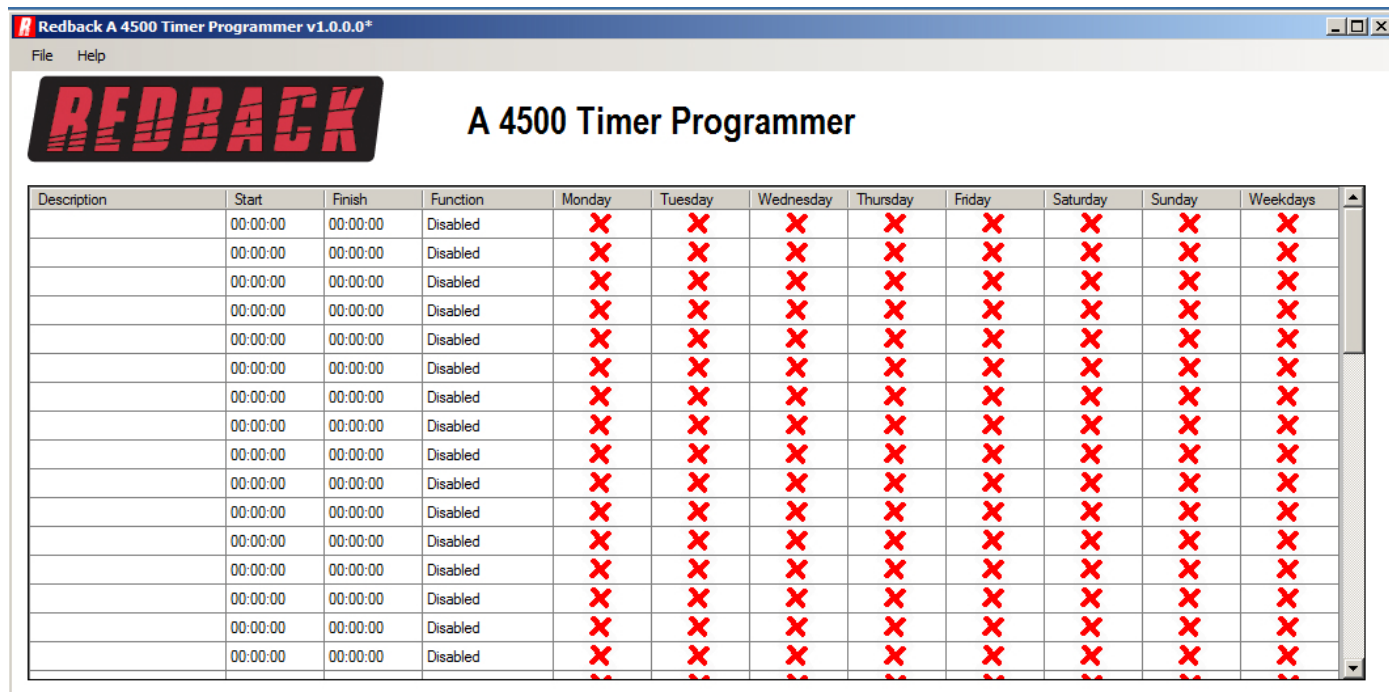

Fig 2.13

All 50 events can be accessed on the screen by scrolling up and down. If you previously saved some timing information using the buttons on the A 4505B then these times should be displayed. Otherwise the timing information should all be blank as shown. The information is saved in a file labelled "config.cnf". This file should already be supplied on the SD card and should be blank as shown.

Entering the timing events is very straight forward.

Double click on any line and a new window should pop up as shown in fig 2.14, which has the event details outlined.

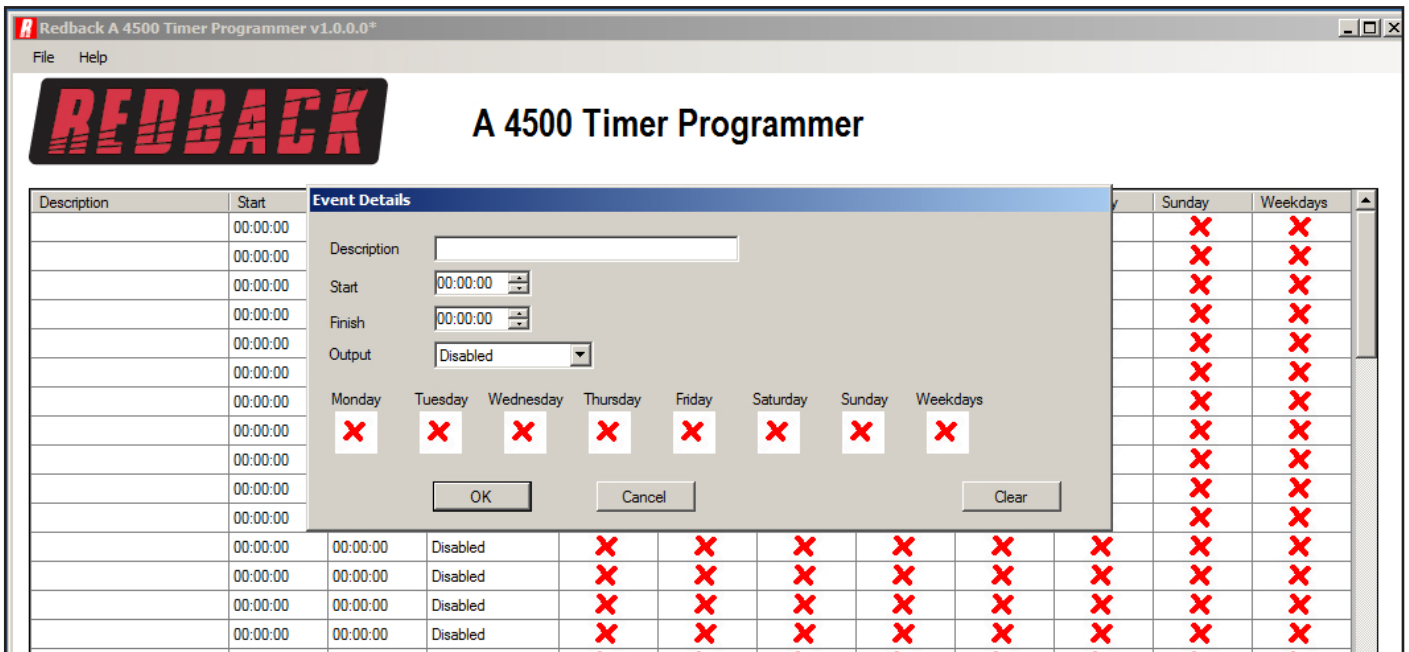

Fig 2.14

An event can now be programmed from this window. A description of the event can be added if desired (such as Pre bell, Morning Tea, Lunch etc), and the start and finish times can all be entered. Selecting the days of the week is as simple as clicking the desired days or selecting the weekdays box, if all weekdays are required.

EVENT OUTPUT

The Event output is selected by the Output dropdown box.

There are fourteen MP3 playback options (Bell, Pre-Bell, Music and 5-15) and a relay only option for the output of the event. The MP3 options relate directly to the folders on the SD card. The Pre-Bell and Music folders can have multiple MP3 files providing random play options. The Bell folder and folders 5-15 must have only one MP3 file each.

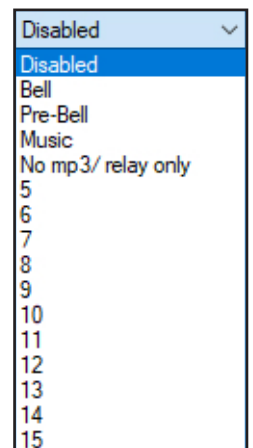

Figure 2.15 shown below illustrates an example. This event is the prebell for a primary school and is programmed to activate 5 minutes before the first bell of the day. The MP3 file located in the Prebell folder on the SD card will be played at 8:55:00 and continue to play until 08:59:59.

Once the event programming has been finalised, press the OK button.

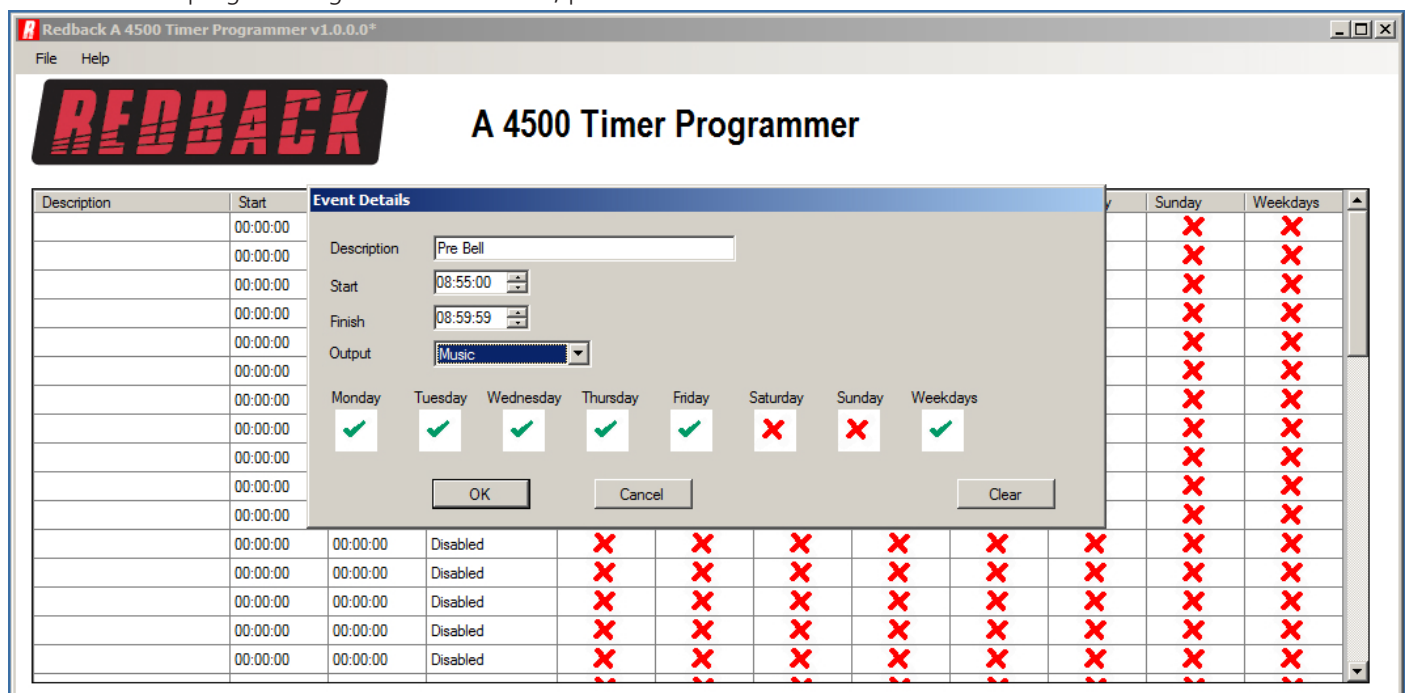

Fig 2.15

The event should now appear in the programming window as shown in fig 2.16.

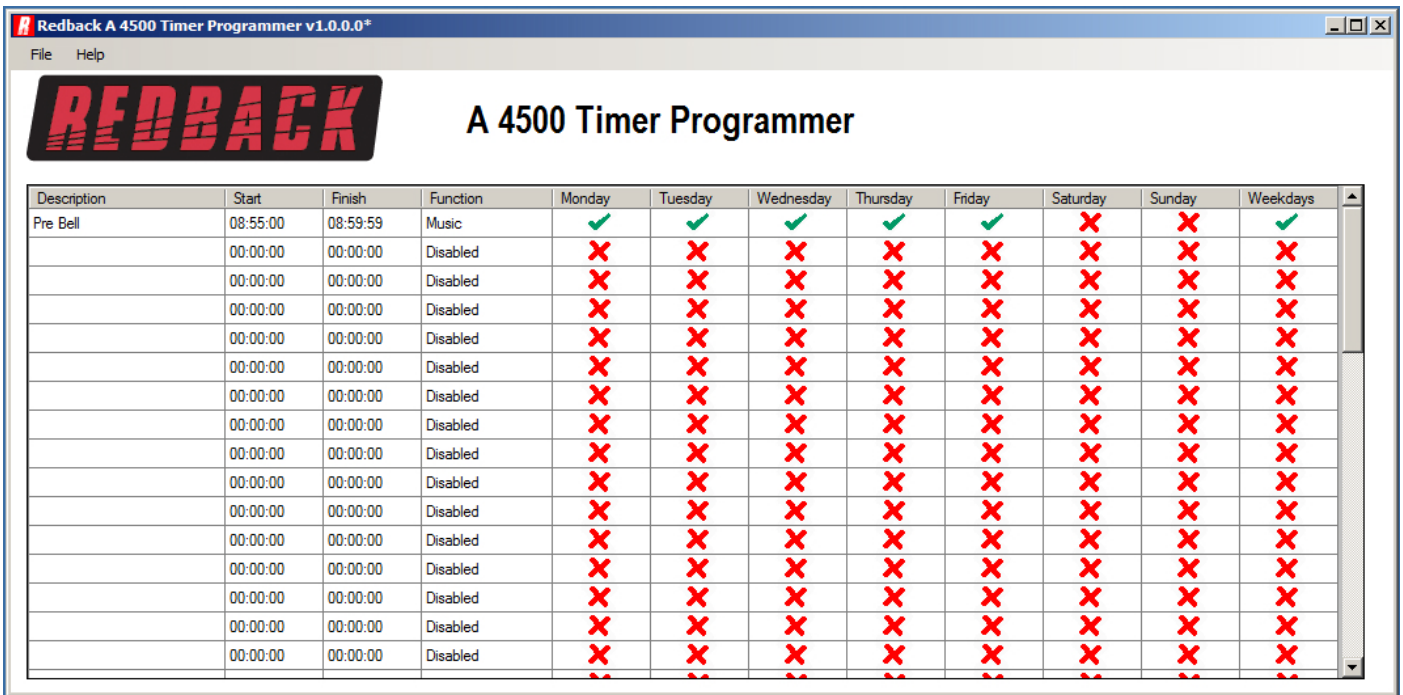

Fig 2.16

Another event is now added by following the same steps. Double click on a blank line and then enter the details required as illustrated in fig 2.17. This is the first bell of the day for the primary school, the A 4505B is being installed at.

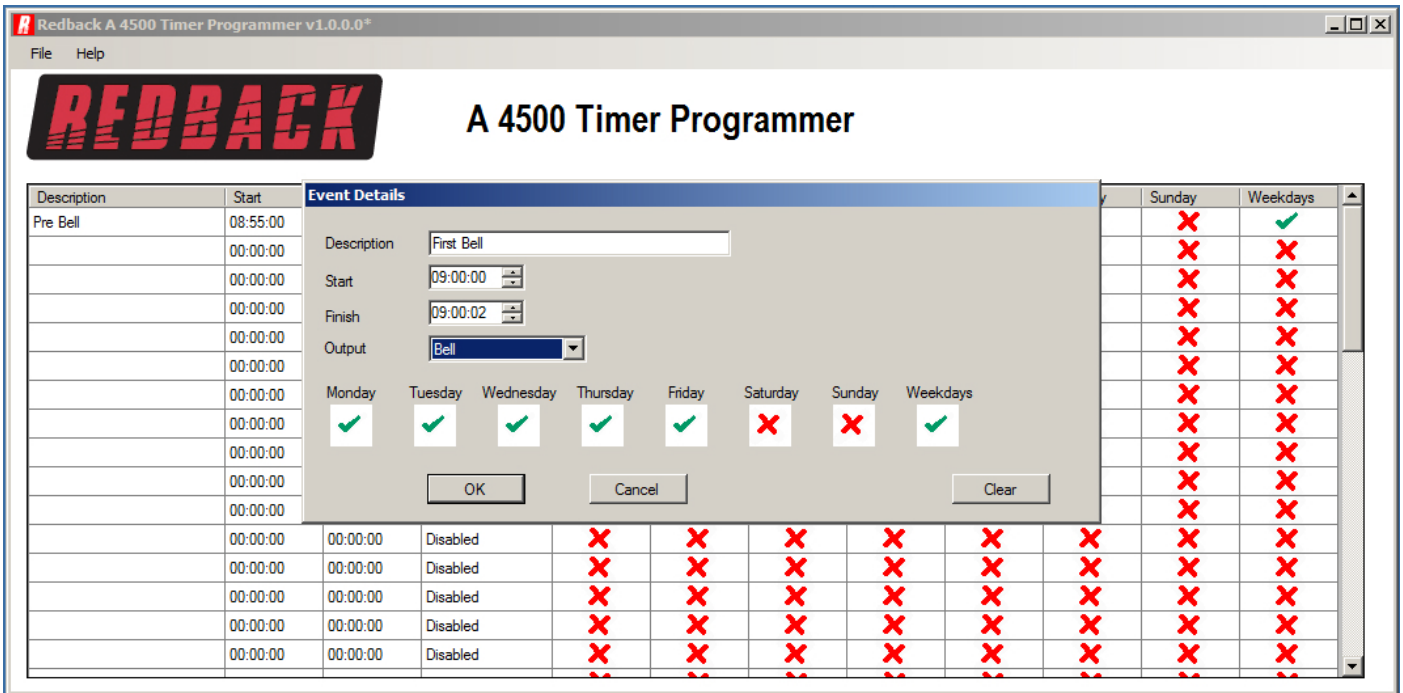

Fig 2.17

Press the OK button and the second event now appears in the programming screen as shown in fig 2.18.

Description	Start	Finish	Function	Monday	Tuesday	Wednesday	Thursday	Friday	Saturday	Sunday	Weekdays
Pre Bell	08:55:00	08:59:59	Music	✓	✓	✓	✓	✓	✗	✗	✓
First Bell	09:00:00	09:00:02	Bell	✓	✓	✓	✓	✓	✗	✗	✓
	00:00:00	00:00:00	Disabled	✗	✗	✗	✗	✗	✗	✗	✗
	00:00:00	00:00:00	Disabled	✗	✗	✗	✗	✗	✗	✗	✗
	00:00:00	00:00:00	Disabled	✗	✗	✗	✗	✗	✗	✗	✗
	00:00:00	00:00:00	Disabled	✗	✗	✗	✗	✗	✗	✗	✗
	00:00:00	00:00:00	Disabled	✗	✗	✗	✗	✗	✗	✗	✗
	00:00:00	00:00:00	Disabled	✗	✗	✗	✗	✗	✗	✗	✗
	00:00:00	00:00:00	Disabled	✗	✗	✗	✗	✗	✗	✗	✗
	00:00:00	00:00:00	Disabled	✗	✗	✗	✗	✗	✗	✗	✗
	00:00:00	00:00:00	Disabled	✗	✗	✗	✗	✗	✗	✗	✗
	00:00:00	00:00:00	Disabled	✗	✗	✗	✗	✗	✗	✗	✗
	00:00:00	00:00:00	Disabled	✗	✗	✗	✗	✗	✗	✗	✗
	00:00:00	00:00:00	Disabled	✗	✗	✗	✗	✗	✗	✗	✗
	00:00:00	00:00:00	Disabled	✗	✗	✗	✗	✗	✗	✗	✗
	00:00:00	00:00:00	Disabled	✗	✗	✗	✗	✗	✗	✗	✗
	00:00:00	00:00:00	Disabled	✗	✗	✗	✗	✗	✗	✗	✗
	00:00:00	00:00:00	Disabled	✗	✗	✗	✗	✗	✗	✗	✗
	00:00:00	00:00:00	Disabled	✗	✗	✗	✗	✗	✗	✗	✗

Fig 2.18

As the events are added they will be listed in chronological order. (I.e. In time order). If a new event was programmed, to start at 08:45:00 for instance, this new event would appear before the prebell event.

Continue to enter the events in this manner and then save the program by clicking file and then save as. The file must be saved as config.cnf on the SD card in place of the file already on the SD card.

With the events now programmed on the SD card, the card can be removed from the PC following windows safe card removal procedures. Make sure the A 4505B is OFF and insert the SD card into the slot in the rear; it will click when fully inserted.

The A 4505B can now be switched back On. If all is well, after the startup screen is displayed the current time and next event should be displayed on the screen.

2.5 SETTING THE CURRENT TIME

Press the “Menu” button on the front of the timer. The unit is now in “Menu Mode” and the screen should display the “Times Adjust” Screen. This is the first of 5 sub menu screens which are navigated by pressing the up and down buttons as shown in Fig 2.19. Pressing the Menu button again will exit the menu structure and return the user to the Main Screen.

Select the CLOCK ADJUST sub menu.

After selecting this option, the screen as shown in Fig 2.20 should appear.

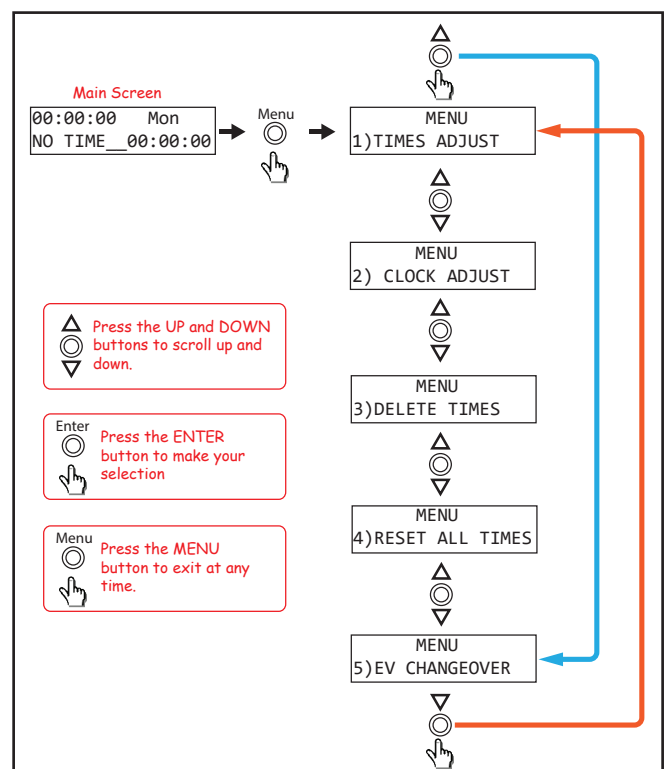

Fig 2.19

EDITING CLOCK 00:00:00 Mon

Fig 2.20

The cursor will be positioned over the hour section of the time. Use the up and down buttons to change the hour and then press the "Enter Button" to confirm the hour. The cursor will move to the minutes section of the time. Use the up and down buttons to change the minutes and then repeat the process again for the seconds. Once the seconds have been updated the cursor will move to the day of the week. Use the up and down buttons again to change the day and then press enter to confirm. The time is now set.

2.6 DELETING A PROGRAMMED TIME

Press the "Menu" button on the front of the timer. The unit is now in "Menu Mode" and the screen should display the "Times Adjust" Screen. This is the first of 5 sub menu screens which are navigated by pressing the up and down buttons as shown in Fig 2.19. Pressing the Menu button again will exit the menu structure and return the user to the Main Screen.

Select the DELETE TIMES sub menu.

After selecting this option, the screen as shown in Fig 2.22 should appear.

TIME1 PREBELL 07:55:00 DELETE?

Fig 2.22

From this point the "Up" and "Down" buttons can be used to scroll through the different times, or press the "Enter" button to delete this time. After deleting the time, a message will indicate that the time has been cleared and the next time will then be displayed on the screen. Press "Enter" to delete, "Menu" to exit or the "Up" and "Down" buttons to scroll to another time.

A time can also be deleted using the PC software.

See section 2.4 for instructions regarding accessing the event programming. A time can be removed by double clicking on the required programmed line and then pressing the "CLEAR" button.

2.7 RESET ALL PROGRAMMED TIMES

Press the "Menu" button on the front of the timer. The unit is now in "Menu Mode" and the screen should display the "Times Adjust" Screen. This is the first of 5 sub menu screens which are navigated by pressing the up and down buttons as shown in Fig 2.19. Pressing the Menu button again will exit the menu structure and return the user to the Main Screen.

Select the RESET ALL TIMES sub menu.

After selecting this option, the screen as shown in Fig 2.23 should appear.

RESET ALL TIMES UP=YES / DN = NO

Fig 2.23

Press the "UP" button to reset all the times programmed and stored on the SD card. Press the "No" button to exit without resetting the times.

2.8 AUDIO CONNECTIONS

Audio Output:

This output consists of stereo RCA sockets with an output of 0dBm into a 600Ω input. This is suitable for most PA amplifier auxiliary inputs.

Rear Panel Volume Controls:

The output levels of the Lockdown/Fire, Prebell, Bell, Music and Voice Over tones can all be adjusted via trimpots located on the rear of the unit.

2.9 VOICE-OVER MESSAGES

The Redback® A 4505B has options for an MP3 message to be played during the Lockdown and the Fire modes.

The voice-over messages are output after every playback of the corresponding Lockdown or Fire MP3 tone.

i.e. if the Lockdown mode is activated the Lockdown MP3 will play once, then the Lockdown voice-over message will play once and this will repeat until cancelled.

The voice-over messages can be enabled by DIP switch 2 (See DIP Switch Settings).

Note: This option will enable both voice-over messages. If only one of the two messages is required, leave the non required voice-over folder empty.

e.g. if the Fire voice over message is required, but the Lockdown voice-over message is not, make sure the folder located in Removable Disk(:)\voice\lockdown is empty.

2.10 DIP SWITCH SETTINGS

The A 4505B has various options which are set by the DIP switches on the rear of the unit. These are outlined below and in figure 2.24.

Switch 1

This switch is used to either loop the Bell/Prebell, or play the Bell/Prebell only once after it has been triggered.

ON = Loop, OFF = Play Once

Switch 2

DIP switch 2 enables or disables the voice over message. The voice-over message is played in between every three cycles of the Fire tone.

ON = Enabled, OFF = Disabled

Switch 3

This switch can be used to lockout the menu button, to deter tampering with the programmed times.

ON = Menu button disabled, OFF = Menu button enabled

Switch 4

This switch can be used to lockout the front isolate button.

ON = Isolate button disabled, OFF = Isolate button enabled

Switch 5-8 Not Used

DIP SWITCH SETTINGS					
SW	ON	OFF	SW	ON	OFF
1	Loop PreBell/Bell Until Cancelled	Play Prebell/Bell Once	2	Voice Over Enabled	Voice Over Disabled
3	Disable Menu Options	Enable Menu Options	4	Disable Isolate Switch	Enable Isolate Switch
5-8	NOT USED				

Fig 2.24

IMPORTANT NOTE:

Ensure power is switched off when adjusting DIP switches.
New settings will be effective when power is switched back on.

2.11 24V OUTPUT CONNECTIONS

These contacts can be used for connection of override relays in remote volume controls, or strobes for unusually noisy environments. An override relay is necessary where attenuators are used so that the Lockdown tone, Fire tone or message is broadcast at full volume regardless of the volume setting on the individual volume control (attenuator).

Lockdown/Fire 24V Out:

These contacts are for switched 24V outputs whenever the Lockdown or Fire tones are activated. These may be used to run external systems such as strobes in unusually noisy environments, or override relays in remote volume controls.

When this output becomes active, 24V will appear between the N/O contact and the GND contact. When this output is not active 24V will appear between the N/C contact and the GND.

Bell 24V Out:

These contacts are for switched 24V outputs whenever the Bell or Relay Only (No MP3 option) are activated. These contacts are for operating an external relay used to operate something like a lunch bell etc.

When this output becomes active, 24V will appear between the N/O contact and the GND contact. When this output is not active 24V will appear between the N/C contact and the GND.

Common 24V Out:

These contacts are for switched 24V outputs whenever the Lockdown, Fire, Bell, Prebell or Relay Only (No MP3 option) tones are activated. When this output becomes active, 24V will appear between the N/O contact and the GND contact. When this output is not active 24V will appear between the N/C contact and the GND.

3.0 REMOTE WALL PLATES

There are a number of wall plates which can be connected to the A 4505B for remote triggering of the Lockdown, Fire and Bell tones and for remotely cancelling any tones which may be active.

3.1 A 2064 and A 2069 Remote Plates

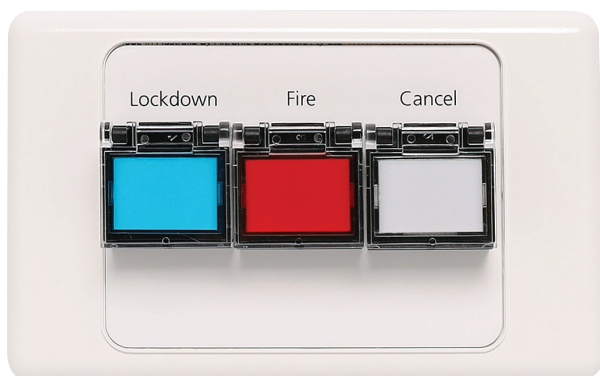

A 2064



A 2069

The Redback® A 2064 wall plate provides a remote means of triggering the Lockdown, Fire and cancel functions of the Redback® A 4505B. Connection from the A 2064 is made to the A 4505B via a minimum of 6 wires as shown in Fig 3.1.

The Redback® A 2069 wall plate provides a remote means of triggering the Lockdown, Fire, Bell and cancel functions of the Redback® A 4505B. Connection is made from the A 2069 to the A 4505B via a minimum of 8 wires as shown in Fig 3.2.

If standard Cat5/6 cable is used for the wiring, the plates can be located up to 30m away from the main unit.

(Note: The A 2064 and A 2069 plates uses screw terminal connections). This can be increased to 100m using heavier gauge cable, which reduces the voltage drop across this distance and ensures the switch leds illuminate.

Redback® A 4505B Lockdown Timer

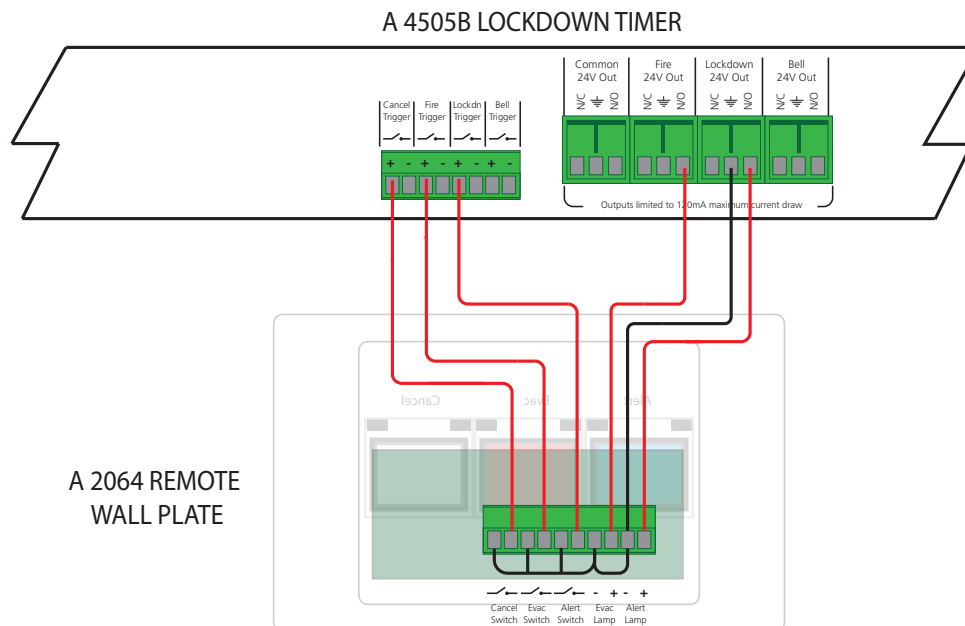

Fig 3.1 Hard wired connection between the A 2064 and A 4505B

The Lockdown/Fire/Cancel switches on the Redback® A 2064 wall plate are connected to the corresponding contacts on the rear of the Redback® A 4505B. While the Lockdown and Fire LED's on the wall plate are connected to the Lockdown and Fire 24V outputs of the Redback® A 4505B.

A minimum of six wires can be used on the A 2064 if the ground connections of the Lockdown and Fire 24V outputs and the Lockdown/Fire and cancel switch grounds are linked together (see Fig 3.2).

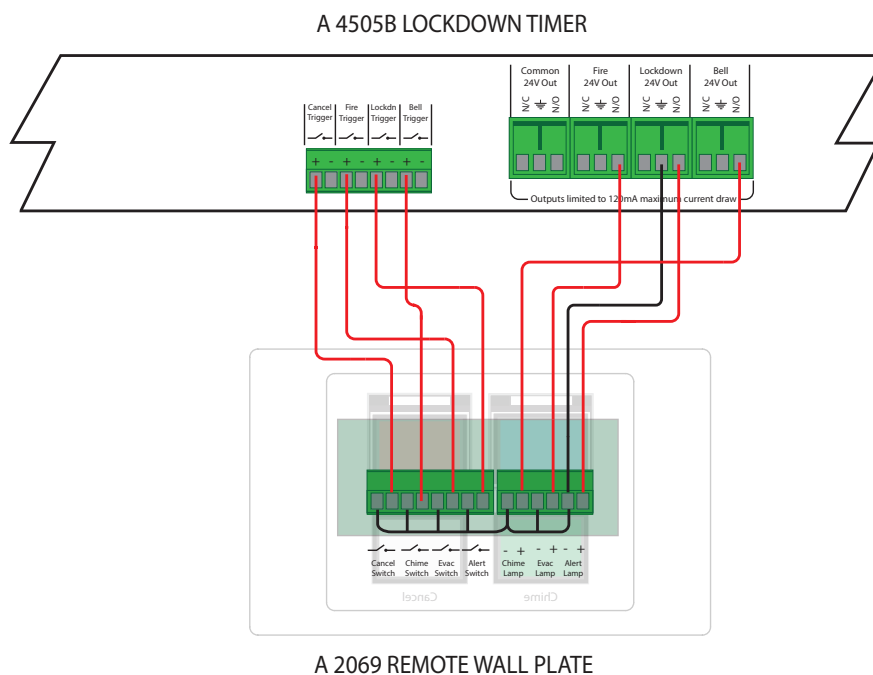

Fig 3.2 Hard wired connection between the A 2069 and A 4505B

The Lockdown/Fire/Chime/Cancel switches on the Redback® A 2069 wall plate are connected to the corresponding contacts on the rear of the Redback® A 4505B. While the Lockdown, Fire and Bell LED's on the wall plate are connected to the Lockdown, Fire and Bell 24V outputs of the Redback® A 4505B.

The cancel LED is not connected.

A minimum of eight wires can be used if the ground connections of the Lockdown, Fire and Bell 24V outputs are linked with the Lockdown, Fire, Chime and Cancel switch grounds (see Fig 3.2).

3.2 A 4599 and A 4599V Remote Plates

The Redback® A 4599 and A 4599V wall plates allow a remote means of triggering the Lockdown, Fire and Bell tones and the cancel function. The switches are momentary operation and must be pressed for up to 3 seconds to activate. The switches have protective “flip up” covers to prevent accidental operation.



Fig 3.3 A 4599



Fig 3.4 A 4599V

Connection is made to the Redback® A 4505B via standard Cat5e cabling as shown in Fig 3.5. There are two RJ45 ports on the rear of the wall plate, either of which can be used.

Only one Redback® A 4599 or A 4599V wall plate is allowed to be connected to the Redback® A 4505B via the RJ45 port.

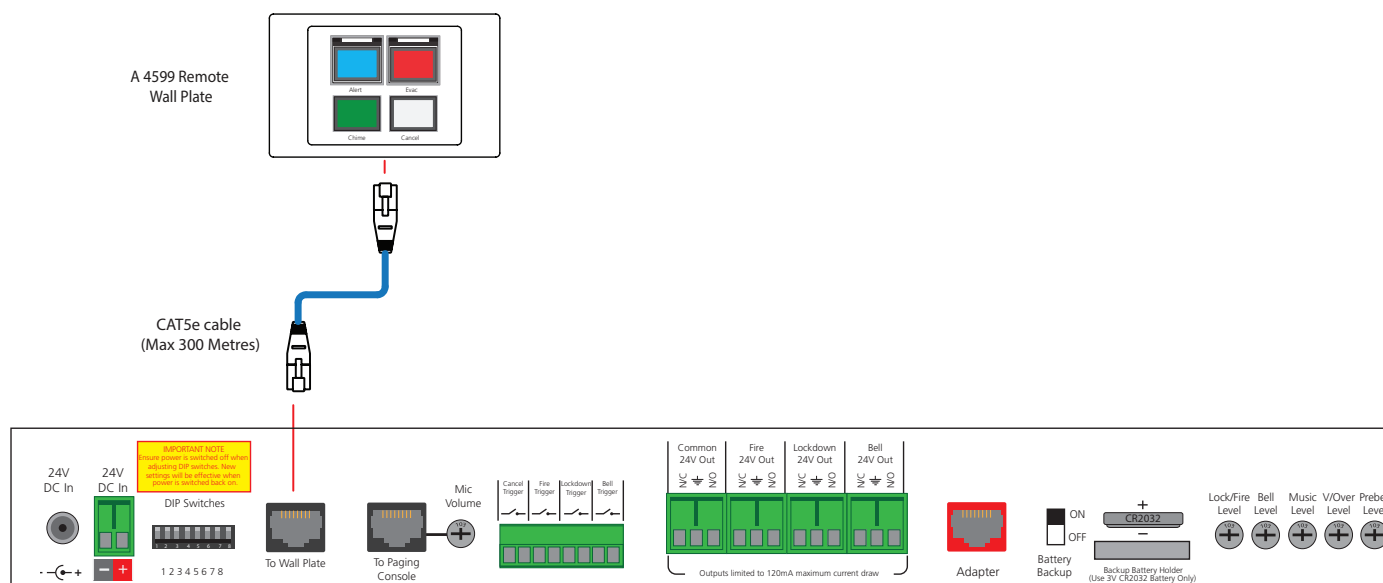

Fig 3.5

4.0 TROUBLE SHOOTING

4.1 SYMPTOMS AND REMEDIES

SYMPTOMS

PC SOFTWARE WILL NOT RUN

ERROR1 (SD card not found)

ERROR2 (SD card not formatted properly)

ERROR4 (Cannot find an MP3 to play)

ERROR7 (Cannot Play MP3)

ERROR8 (Fault with Configuration File)

Power switch is illuminated Red but unit doesn't work

Unit will not play MP3 files.

Unit doesn't play an MP3 at the appointed time.

Alarm times have been updated by user but the times don't change.

REMEDIES

The PC software for this product may not run on all PC's. The .NET framework on the PC has to be updated to .NET Framework 4. Available for download on the microsoft website.

CHECK SD CARD HAS BEEN INSERTED CORRECTLY

CHECK SD FORMATTED CORRECTLY

CHECK MP3 FILES INSTALLED

CHECK FORMAT OF MP3 (It cannot be WAV or AAC)

MP3 files cannot be "Read Only" See page 9.

Note 1: MP3 files should have the following specifications for optimum performance. 128kbps, 44.1kHz, 32bit, VBR or CBR, Stereo (even better as mono).

CHECK CONFIGURATION FILE (Incorrect time??)

The unit is in standby mode. Press the Power/Standby switch. The unit is ON when the Blue ON LED is illuminated.

Make sure all MP3 files are not "Read Only". See page 9.

This could be caused by MP3 files which are Read Only. The unit will attempt to play the file but not be able to play it, hence the MP3 will not be played at the appointed time.

The times are saved to a file named "config.cnf". This file cannot be named anything else. It must also be saved to the root folder of the SD card.

4.2 RJ45 cabling configuration for system components (568A 'Straight through')

System components are connected using “pin to pin” configuration RJ45 data cabling as shown in fig 4.2. When installing ensure all connections are verified with a LAN cable tester before switching any system component on.

Failure to follow the correct wiring configuration may result in damage to system components.

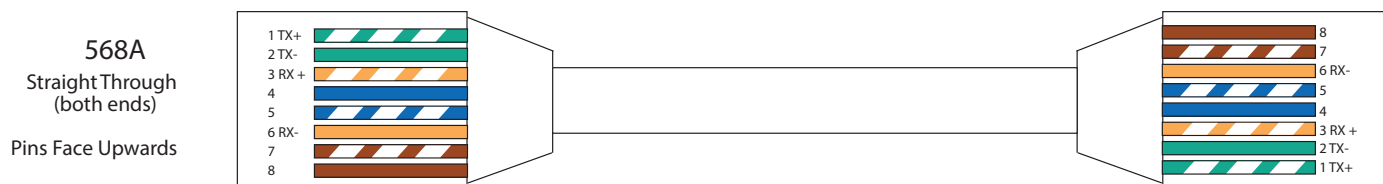

Fig 4.2

WARNING

System components are connected using standard “pin to pin” configuration RJ45 data cabling. When installing ensure all connections are verified before switching any system component on.

Failure to follow the correct wiring configuration may result in damage to system components.

5.0 FIRMWARE UPDATE

It is possible to update the firmware for this unit by downloading updated versions from www.altronics.com.au or redbackaudio.com.au.

To perform an update, follow these steps.

- 1) Download the Zip file from the website.
- 2) Remove the SD card from the A 4505B and insert it into your PC. (Follow the steps on page 8 to open the SD card).
- 3) Extract the contents of the Zip file to the root folder of the SD Card.
- 4) Rename the extracted .BIN file to update.BIN.
- 5) Remove the SD card from the PC following windows safe card removal procedures.
- 6) With the power turned OFF, insert the SD card back into the A 4505B.
- 7) Turn the A 4505B ON. The unit will check the SD card and if an update is required the A 4505B will perform the update automatically.

Redback® A 4505B Lockdown Timer

6.0 SPECIFICATIONS

OUTPUT LEVEL:.....0dBm
DISTORTION:.....0.01%
FREQ. RESPONSE:.....140Hz - 20kHz
SIGNAL TO NOISE RATIO:
 Lockdown/Fire/Chime:.....-70dB typically

OUTPUT CONNECTORS:

Audio Output:.....RCA Stereo Socket
Common 24V DC Out:.....Screw Terminals
Lockdown 24V DC Out :... Screw Terminals
Fire 24V DC Out:.....Screw Terminals
Bell 24V DC Out:.....Screw Terminals

PLEASE NOTE:

Output loads limited 0.12Amp each

INPUT CONNECTORS:

24V DC Power:.....Screw Terminals
24V DC Power:.....2.1mm DC Jack
Remote Lockdown, Fire, Bell, Cancel:
 Screw Terminals

MUTING:.....Via Microphone Switch Contact
CONTROLS:

Lockdown/Fire:.....Rear Volume
Voice over:.....Rear Volume
Bell:.....Rear Volume
Prebell:.....Rear Volume
Music:.....Rear Volume

Power:.....On/Off Switch
Lockdown Switch:..Illuminated Push Switch
Fire Switch:.....Illuminated Push Switch
Bell Switch:.....Illuminated Push Switch
Cancel Switch:.....Push Switch

INDICATORS:.....Power on, MP3 error, Prebell

MP3 FILE FORMAT:128kbps, 44.1kHz, 32bit,
 VBR or CBR, Stereo (even better as mono).

POWER SUPPLY:..... 24V DC

DIMENSIONS:≈..... 482W x 175D x 44H

WEIGHT: ≈..... 2.1 kg

COLOUR:Black

* Specifications subject to change without notice

All Australian made Redback products are covered by a 10 year warranty.

Should a product become faulty please contact us to obtain a return authorisation number. Please ensure you have all the relevant documentation on hand. We do not accept unauthorised returns. Proof of purchase is required so please retain your invoice.