

ROSSLARE

INSTRUCTION MANUAL



AC-S43

**STAND-ALONE
ACCESS CONTROL UNIT**

ROSSLARE
www.rosslare.com.hk

9J-IDR-048 / 0706-0820048-00

InteliDoor 
Smart Access Control

03/02

Contents

INTRODUCTION	4
Technical Specifications	5
Key Features	6
INSTALLATION	8
Mounting the AC-S43 Controller	8
Wiring Diagrams	11
FEATURES AND CONCEPTS	
Normal, Secure, & Master Users	14
Modes Of Operation	15
Changing the Modes of Operation	16
Auxiliary Output and Input	17
Request To Exit (REX) Button	18
Case and Back Tamper	18
BL-D40 External Sounder	19
PROGRAMMING THE AC-S43	20
Entering Programming Mode	21
Exiting Programming Mode	21
1 Changing the Open Code	22
2 Changing the Auxiliary Code	22
3 Changing the Programming Code	23
4 Changing the Normal / Secure Code	24
5 Changing the Normal / Bypass Code	25
Door Chime Settings	25
6 Defining the Auxiliary Input and Output	26
Auxiliary Mode Quick Reference Guide	27
Setting Fail Safe / Secure Operation	28
Setting Tamper Siren Time	28
Setting the Lock Strike Release Time	28
7 Enrolling Primary and Secondary Codes	29
8 Deleting Primary and Secondary Codes	32
9 Lock Strike Relay and Auxiliary Relay	34
Code Assignment	
0 Return to Factory Default Settings	36

Replacing a lost Programming Code	37
Replacing a lost Normal / Secure Code	37

APPENDIX	
Glossary	38

WARRANTY	41
-----------------------	-----------

TECHNICAL SUPPORT	43
--------------------------------	-----------

Introduction

The AC-S43 is a vandal resistant keypad access control unit suitable for external applications.

The unit accepts up to 500 users and provides entry via the use of PIN codes.

Equipment provided

The following is provided as part of every AC-S43 package:

- AC-S43 Access Control Unit.
- Installation Kit
- Installation and Operating Instructions

Additional Equipment Required

- 1) Electric Lock Strike Mechanism**
Fail Safe (Power to Lock) or Fail Secure (Power to Open)
- 2) Power Supply with Backup Battery**
12 to 24V DC (From a Regulated Power Supply)
16V AC (From a Transformer)
- 3) Request To Exit (REX) Button**
Normally Open Type - Switch is closed when pressed.
- 4) BL-D40 External Sounder (Optional)**
Provides Siren, Bell, and Chime functions to AC-S43

Other Rosslare accessories can be found at Rosslare's Web Site:

<http://www.rosslare.com.hk>

Technical Specification

Electrical Characteristics

Operating Voltage Range:

12 to 24V DC From a Regulated Power Supply
16V AC From a Transformer

Maximum Input Current:

Standby: 20mA Not including attached devices
Max: 115mA Not including attached devices

Relay Outputs:

Lock Strike Relay Form C, 5A
Auxiliary Relay Form C, 5A

Inputs:

REX N.O., Dry Contact
Auxiliary Input (In / Monitor) N.C., Dry Contact in Monitor Mode
N.O., Dry Contact in Input Mode

LEDs

Two Tri-colored LEDs

Environmental Characteristics

Operating Temperature: -25°F to 145°F (-31°C to 63°C)

Operating Humidity: 0 to 95% (Non-Condensing)
Suitable for outdoor use. (IP 65)

Mechanical Characteristics

Dimensions:

5.91" (150mm) L x 1.65" (42mm) W x 1" (27mm) D

Weight:

0.9 lbs (400g)

Key Features

Here are some of the AC-S43's key features:

- Built in piezoelectric keypad for PIN code entry
- Auxiliary Input & Auxiliary Output
- Eight Auxiliary Modes including:
 - Door Ajar
 - Forced Door
 - Shunt
 - Door Monitor
 - Normal / Secure
- Internal Buzzer
- Comes with security screw and security screw tool
- Two Status / Programming Interface LED's
- Three User Levels
 - Normal User
 - Secure User
 - Master User
- Three Modes of Operation
 - Normal Mode
 - Bypass Mode
 - Secure Mode
- "Code Search" feature that helps make maintaining user codes easier.
- Input for Request to Exit (REX) button.
- Comes with mounting template for easier installation.
- Built in Case and Back Tamper
- Bell, Chime, Siren, and Strobe features available with BL-D40.
- Bell, Chime, Siren, Battery Backup, Tamper Output (Open Collector 20mA) features available with PS-X41 (Output Power 1.2A) and PS-X42 (Output Power 1.8A).
- Programmable Siren Time
- Programmable Lock Strike Release Time
- Comes with Suppression Diode (1N4004)

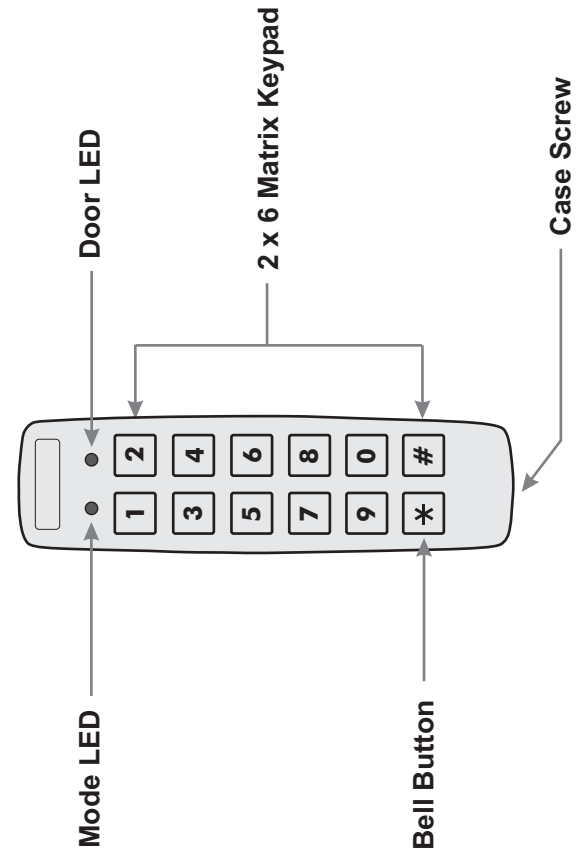

Installation

Mounting the AC-S43 Controller

- 1) Before starting, select the location to mount the AC-S43 controller. This location should be at shoulder height.
- 2) Drill holes into the back of the metal according to how you want to mount the AC-S43. For US Gang Box installation there are two hole indicators on the back of the metal cover specifically aligned for the US Gang Box. (Shown marked as "A" in diagram below).

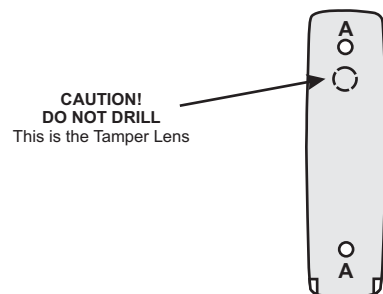

- 3) Screw the AC-S43 back cover to its mounting location.
- 4) Wire the controller according the wiring instructions of the following page.
- 5) Return the front cover of the AC-S43 to the mounted back plate.
- 6) Secure the front cover by using the supplied security screw in the Installation Kit. An L-Shaped tool is provided for use when tightening the security screw.

Wiring the AC-S43

The controller is supplied with a 16-inch pigtail, having a 6-conductor cable. To wire the Controller, perform the following steps.

- 1) Prepare the controller cable by cutting the cable jacket back 1¼ inches and strip the wire ½ inch.
- 2) Splice the controller pigtail wires to the corresponding devices and cover each connection. Refer to the wire color guide provided below and to the wiring diagrams provided on the following pages.

Wire Color Guide

COLOR	DESCRIPTION
RED	V INPUT
BLACK	GROUND
GREEN	C1
WHITE	C2

- 3) Trim and cover all conductors that are not used.

A few of the typical wiring diagrams are shown on the next three pages; for other wiring diagram examples refer to the support section of the Rosslare Web Site.

<http://www.rosslare.com.hk/support>

Wiring Diagrams

Wiring the Lock Strike Relay and REX

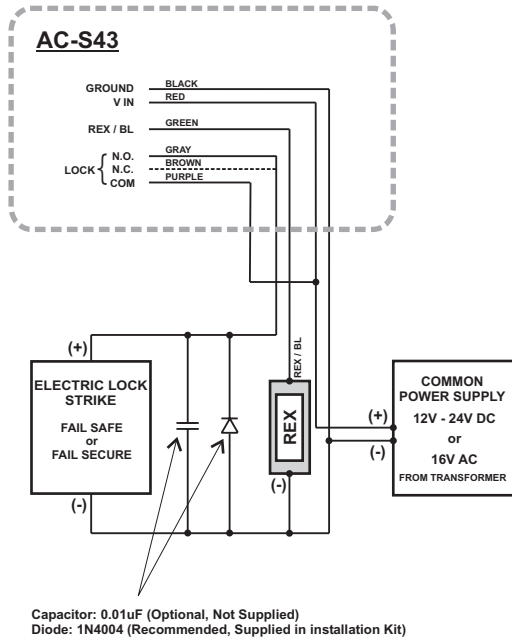

Wiring the Auxiliary Input and Output

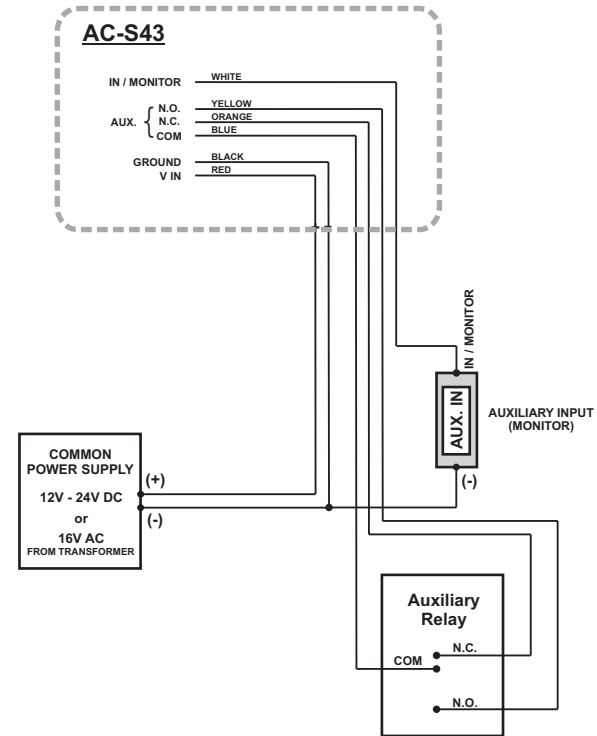

Wiring the BL-D40 External Sounder

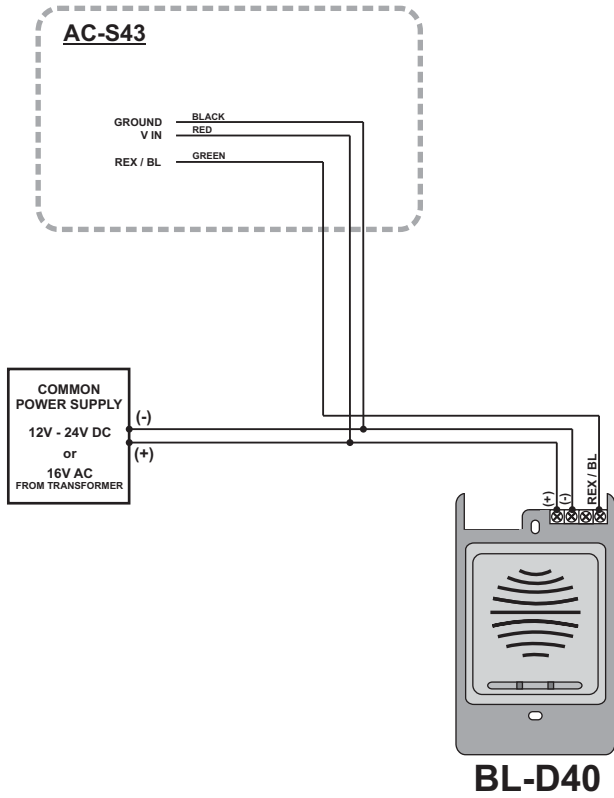

THIS PAGE IS INTENTIONALLY BLANK

Normal, Secure, & Master Users

The AC-S43 accepts up to 500 users and provides entry via the use of PIN codes. Each user is provided with two code memory slots, Memory Slot 1 (Primary Code) and Memory Slot 2 (Secondary Code).

The way in which the two memory slots are programmed determines a users access level and also determines the way in which the AC-S43 grants access in its three Modes of Operation.

There are three user levels:

Normal User

A Normal User only has a Primary Code and is only granted access when the AC-S43 is in Normal or Bypass Mode.

Secure User

A Secure User must have a Primary and Secondary Code programmed, the two codes must not be the same. The Secure User can gain access when the AC-S43 is in any of its three Modes of Operation. In Normal Mode the Secure User must use their Primary Code to gain entry. In Secure Mode the Secure User must present both their Primary and Secondary Codes in order to gain entry.

Master User

A Master User must have both Primary and Secondary Codes programmed with the same PIN code. The Master User can gain access during any Mode of Operation by presenting their PIN code to the controller. (The Master User is convenient but is less secure than a Secure User).

Modes of Operation

The AC-S43 has 3 Modes of Operation:

1) Normal Mode.

- Mode LED is green

Mode   Door
GREEN

Normal Mode is the default mode. In Normal Mode the door is locked until a Primary Code is presented to the controller. Special codes such as "Open Code" and "Auxiliary Code" are active in Normal mode. (See Page 22 for more information on the Open & Auxiliary Codes).

2) Bypass Mode.

- Mode LED is orange

Mode   Door
ORANGE

In Bypass Mode, access to the premises is dependent on whether the controller's Lock Strike Relay is programmed for Fail Safe Operation or Fail Secure Operation.

When the Lock Strike Relay is programmed for Fail Secure Operation, the door is locked until the Door Bell Button is pressed.

When the Lock Strike Relay is programmed for Fail Safe Operation, the door is constantly unlocked.

3) Secure Mode.

- Mode LED is red

Mode   Door
RED

Only Secure and Master Users can access the premises during the Secured Mode.

A Secure User must enter their Primary and Secondary Codes to gain entry. After entering their Primary Code the Door LED will flash green for 10 seconds, during which the Secondary Code must be entered.

A Master User only needs to present their PIN code once to gain entry.

Changing the Modes of Operation

Changing from Normal Mode to Secure Mode:

The default factory setting for the Normal / Secure Code is 3838

1) Enter the 4-digit Normal / Secure Code. **Mode**  **GREEN** **Door**

• Mode LED will flash red **Mode**  **RED** **Door**

2) Press the "#" key to confirm the Mode change. **Mode**  **RED** **Door**

• Mode LED is red

The AC-S43 Auxiliary Input can also be used to switch the Mode of Operation from Normal to Secure and vice versa. Refer to "Defining the Auxiliary Input and Output" on Page 26.

Changing from Secure Mode to Normal Mode:

The default factory setting for the Normal / Secure Code 3838

1) Enter the 4-digit Normal / Secure Code. **Mode**  **RED** **Door**

• Mode LED will flash green. **Mode**  **GREEN** **Door**

2) Press the "#" key to confirm the Mode change. **Mode**  **GREEN** **Door**

• Mode LED will turn green.

The Auxiliary Input of the AC-S43 can also be used to switch the mode of operation from Secure to Normal Mode and vice versa. Refer to "Defining the Auxiliary Input and Output" on Page 26.

Changing from Normal Mode to Bypass Mode:

See Page 24 to create / modify the Normal / Bypass Code

1) Enter the 4 digit Normal / Bypass Code. **Mode**  **GREEN** **Door**

• Mode LED will flash orange **Mode**  **ORANGE** **Door**

2) Press the "#" key to confirm the Mode change. **Mode**  **ORANGE** **Door**

• Mode LED will turn orange

Changing from Bypass Mode to Normal Mode:

See Page 24 to create/modify the Normal / Bypass Code

1) Enter the 4 digit Normal / Bypass Code. **Mode**  **ORANGE** **Door**

• Mode LED will flash green **Mode**  **GREEN** **Door**

2) Press the "#" key to confirm the Mode change. **Mode**  **GREEN** **Door**

• Mode LED will turn green

Auxiliary Input and Output

The AC-S43 auxiliary input and output can be configured in 8 different combinations, for optimum usability in different applications.

For more information, refer to "Defining the Auxiliary Input and Output" on Page 26.

Request to Exit (REX) Button

The REX button must be located inside the premises to be secured and is used to open the door without the use of a proximity card or PIN code, it is usually located in a convenient location, e.g. Inside the door or at a receptionist's desk. The function of the REX button depends on whether the Lock Strike Relay is programmed for Fail Safe Operation or Fail Secure Operation. The door chime in the BL-D40 does not sound when the REX button is used to open the door.

- 1) Fail Secure Operation: From the moment the REX button is pressed, the door will be unlocked until the "Lock Strike Release Time" has passed. After this time, the door will be locked even if the REX button has not been released.
- 2) Fail Safe Operation: From the moment the REX button is pressed, the door will be unlocked until the REX button is released, plus the "Lock Strike Release Time". In this case the "Lock Strike Relay" only begins its count down once the REX button has been released.

Case and Back Tamper

If the case of the controller is opened or the controller is removed from the wall, a tamper event is triggered and a coded tamper signal is sent to a BL-D40, PS-X41 Series or PS-X42 Series Power Supply, or other compatible device.

If the BL-D40 External Sounder, PS-X41 Series or PS-X42 Series Power Supplies receive a Tamper Event Signal, they will activate a Siren and if available a Strobe Light. The Siren time can be easily programmed in the AC-S43 from 0 to 9 minutes.

Clearing a tamper event is done by entering a valid User or Open Code that will open the Lock Strike Output in the current Mode of Operation. For example, while in Secure Mode, using the Open Code to clear tamper event will not work because the Open Code does not work in Secure Mode. However, applying a Master Code or Secure Code will clear the tamper event in Secure Mode.

BL-D40 External Sounder

The BL-D40 External Sounder is compatible with the AC-X31, AC-X32, AC-X41, and AC-X42 series Standalone Controllers (For a more up-to-date list of compatible products check the Rosslare Web Site at www.rosslare.com.hk). It is designed to operate indoors and installed within the premises to be secured. The Sounder can be powered by 16V AC or 12 to 24V DC power supply.

The BL-D40 is capable of emitting four different types of alerts both audible and visual; Bell, Door Chime, Siren, and Strobe Light.

- 1) The Bell always sounds when the controller's doorbell button is pressed.
- 2) The Door Chime can be programmed to sound whenever the controller unlocks the door (the Door Chime does not sound when the REX button is used to open the door).
- 3) The Siren can be programmed to sound when the case of the controller is opened or when the controller is removed from the wall. The controller can also program the length of the Siren in the BL-D40.

The Controller communicates with the BL-D40 using a coded proprietary Rosslare communications protocol. This provides a more secure link between the Controller and the BL-D40. If the BL-D40 receives any unrecognized codes on its communication line or communication between the controller and the BL-D40 are severed, the Strobe with flash repeatedly until the communication problem has been resolved.

Programming the AC-S43

Programming the AC-S43 is done solely via the unit's keypad driven Programming Menu System. To reach the Programming Menu System the AC-S43 must first be placed into Programming Mode. See "Entering Programming Mode" on Page 21 for more information.

During the AC-S43's manufacturing process certain codes and settings are pre-programmed. These settings are called the "Default Factory Settings".

The table below shows the names of all the AC-S43 Menus. It also shows of all the AY-Q41's default factory codes and settings.

Programming Menu

Factory Settings	Menu Description	Menu Number
2580	Change Open Code 1	1
0852	Change Auxiliary Code	2
1234	Change Program Code	3
3838	Change Normal / Secure Code	4
N/A	Change Normal / Bypass Code	5
0004	Change Door Release Time	6
2004	Define Auxiliary Inputs / Outputs Code Assignment with Strike/Auxiliary Return to Default Factory Setting	9 0

You will find a complete description and instructions for each of the above menu items on the following pages.

Entering Programming Mode

- 1) Press the "#" key two times within 2 seconds.
 - Mode LED will turn off
 - Door LED will turn red

Mode Door
RED

- 2) Enter your 4-digit Programming Code.

If the Programming Code is valid the door LED will turn green and the AC-S43 will be in Programming Mode.

Mode Door
GREEN

- Note:**
- The AC-S43 must be in Normal Mode to enter the Programming Mode.
 - The factory default Programming Code is 1234
 - If a Programming Code is not entered within 5 seconds, the AC-S43 will return to Normal Mode.

Exiting Programming Mode

- 1) To exit the Programming Mode at any time:

Press the "#" key two times within 2 seconds.

Mode Door
GREEN

- You will hear 3 beeps.
- The Door LED will be off
- The Mode LED will turn green







This indicates that the AC-S43 has returned to Normal Mode.

- 2) Wrong entries may reset the controller back to Normal Mode.
- 3) While in Programming Mode if no key is pressed for 1 minute the AC-S43 will exit programming mode and return to Normal Mode.
- 4) A short press on "#" key may also return the system to Normal Mode in certain Programming Modes.

Changing the Open Code

The Open Code is mainly used as a method to quickly test the Lock Strike Relay during installation.

The Default Factory Setting for the Open Code is 2580. When the first user is added to the controller, the default Open Code will automatically be deleted, ready for a new Open Code to be re-entered.







- 1) Enter Programming Mode
Mode  Door 
GREEN
- 2) Press "1" to enter **Menu 1**
• The Mode LED will turn red
Mode  Door 
RED GREEN
- 3) Enter the new 4-digit code you wish to set as Open Code.

- 4) System returns to Normal Mode
• The Door LED will turn off
• The Mode LED will turn green
Mode  Door 
GREEN

Note: - Open Code does not function in Secure Mode.
- Wrong entries will return the controller to Normal Mode.
- Code 0000 will erase and deactivate the Open Code.

Changing the Auxiliary Code







The Auxiliary Code is mainly used as a method to quickly test the Auxiliary Relay during installation.

The Default Factory Setting for the Auxiliary Code is 0852. When the first user is added to the controller, the default Auxiliary Code will automatically be deleted, ready for a new Auxiliary Code to be re-entered.

- 1) Enter Programming Mode
Mode  Door 
GREEN
- 2) Press "2" to enter **Menu 2**
• The Mode LED will turn red
Mode  Door 
ORANGE GREEN
- 3) Enter the new 4-digit code you wish to set as Open Code.

- 4) System returns to Normal Mode
• You will hear three beeps
• The Door LED will turn off
• The Mode LED will turn green
Mode  Door 
GREEN

Note: - Auxiliary Code does not work in Secure Mode.
- Auxiliary Code only works when the Auxiliary Mode is 1 or 2.
- Code 0000 will erase and deactivate the Auxiliary Code.

Changing the Programming Code

- 1) Enter Programming Mode
Mode  Door 
GREEN
- 2) Press "3" to enter **Menu 3**
• The Mode LED will turn green.
Mode  Door 
GREEN GREEN
- 3) Enter the new 4-digit code you wish to set as Programming Code

- 4) System returns to Normal Mode
• You will hear three beeps
• The Door LED will turn off
• The Mode LED will turn green
Mode  Door 
GREEN

Note: - Programming Code can not be erased, i.e. the code 0000 is not valid and will not erase the Programming Code.

Changing the Normal / Secure Code

- 1) Enter Programming Mode Mode Door
GREEN
- 2) Press "4" to enter **Menu 4** Mode Door
RED GREEN
 - The Mode LED will flash red
- 3) Enter the new 4-digit code you wish to set as Normal / Secure Code ? ? ? ?
- 4) System returns to Normal Mode Mode Door
GREEN
 - You will hear three beeps
 - The Door LED will turn off
 - The Mode LED will turn green

Note: - When the Auxiliary Mode is 1, 2, 3, or 4 the Auxiliary Input takes priority over the Normal / Secure Code.

Changing the Normal / Bypass Code and Door Chime Settings

The Normal / Bypass Code is also used to turn the Door Chime off and on.

- 1) Enter Programming Mode Mode Door
GREEN
- 2) Press "5" to enter **Menu 5** Mode Door
ORANGE GREEN
 - The Mode LED will flash orange.
- 3) Below is a list of the four different ways that the Normal / Bypass Code and Door Chime can be programmed.
 - a) Disable Bypass Mode - Disable Door Chime
 - b) Disable Bypass Mode - Enable Door Chime
 - c) Enable Bypass Mode - Disable Door Chime
 - d) Enable Bypass Mode - Enable Door Chime

a) Disable Bypass Code - Disable Door Chime

Enter the 4-digit code 0000 0 0 0 0

b) Disable Bypass Code - Enable Door Chime

Enter the 4-digit code 0001 0 0 0 1

c) Enable Bypass Code - Disable Door Chime

Enter any 4-digit code ending with 0 ? ? ? 0

d) Enable Bypass Code - Enable Door Chime

Enter any 4-digit code not ending with 0 ? ? ? ~~0~~

- 4) System returns to Normal Mode Mode Door
GREEN
 - You will hear three beeps
 - The Door LED will turn off
 - The Mode LED will turn green

Note: - The chime is only generated when the Lock Strike Relay is activated due to a valid code entry.

Defining Auxiliary Inputs/Outputs

- 1) Enter Programming Mode

Mode Door
 GREEN GREEN

- 2) Press "6" to enter **Menu 6**
 - The Mode LED will flash green

Mode Door
 GREEN GREEN

- 3) Construct the 4-digit code using the instructions below:

2

?

?

?

Auxiliary Mode ↑ ↑ ↑
 Auxiliary Setting ↑ ↑

Auxiliary Mode

In addition to the Lock Strike Relay and Lock Strike REX, the AC-S43 features an Auxiliary Output Relay and an Auxiliary Input. The Auxiliary Mode defines the function of the Auxiliary Input and Output.

The Auxiliary Mode also determines if the Auxiliary Output Relay is set for Fail Safe or Fail Secure Operation.

Auxiliary Settings

Each of the Auxiliary Modes has a two digit setting that affects how the Auxiliary Mode functions.

- 4) System returns to Normal Mode

Mode Door
 GREEN

 - You will hear three beeps
 - The Door LED will turn off.
 - The Mode LED will turn green

The definitions for the Auxiliary Modes can be found in the table on the next page.

Auxiliary Mode Quick Reference Guide

Auxiliary Mode	Auxiliary Input	Auxiliary Output Activated On	Aux. Relay	Auxiliary Settings <small>(All times and delays are in seconds)</small>
0	REX-2	Valid Code or REX-2	N.O.	01 to 99 Aux. Relay Release Time 00 Aux. Relay Toggles
1	Normal / Secure	Valid Code	N.O.	01 to 99 Aux. Relay Release Time 00 Aux. Relay Toggles
2	Normal / Secure	Bell Button	N.O.	01 to 99 Aux. Relay Release Time 00 Aux. Relay Toggles
3	Normal / Secure	Tamper Event	N.C.	01 to 99 Aux. Relay Release Time 00 Aux. Relay activated by Tamper
4	Normal / Secure	Direct Shunt	N.O.	00 to 99 Shunt Time*
5	Door Monitor*	Shunt*	N.C.	00 to 99 Maximum Shunt Time*
6	Door Monitor*	Forced Door*	N.C.	00 to 99 Forced Delay*
7	Door Monitor*	Door Ajar*	N.C.	00 to 99 Ajar Delay*

* For more information and the definitions of these terms refer to the glossary on Page 38.

Setting Fail Safe/Secure Operation Setting Tamper Siren Time Setting the Lock Strike Release Time

1) Enter Programming Mode



2) Press "6" to enter **Menu 6**

- The Mode LED will flash green

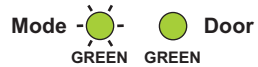

3) Construct the 4-digit code using the instructions below:

First Digit

For Fail Secure Operation the first digit should be "0"
For Fail Safe Operation the first digit should be "1"

Second Digit

Tamper Siren Time, enter any number from 1 to 9 minutes.

Third and Fourth Digit

Enter the number of seconds from (1 to 99 seconds) that you want the Lock Strike to be released.

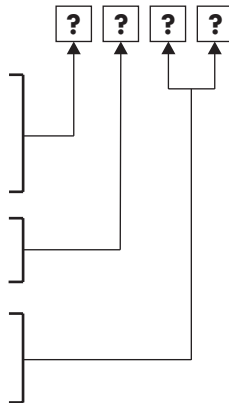

For example 0 5 1 2 means Fail Secure Operation, with a 5 minute Tamper Siren Time, and a 12 second Lock Strike release time.

4) System returns to Normal Mode

- You will hear three beeps
- The Door LED will turn off.
- The Mode LED will turn green



Enrolling Primary & Secondary Codes

Primary Codes

- Primary Codes can only be enrolled to an empty User Slot, i.e a slot where there is no existing Primary Code.
- Primary Codes must be unique, i.e. one users Primary Code may not be the same as another users Primary Code.
- Primary Codes cannot be the same as any system codes, such as the Normal / Secure Code or Open Code.
- Users who hold a Primary Code can gain entry only during Normal Mode.

Secondary Codes









- Secondary Codes can only be enrolled to User Slot that already has a Primary Code enrolled but no Secondary Code.
- Secondary Codes do not have to be unique, i.e. multiple users can all hold the same Secondary Code.
- Secondary Codes cannot be the same as any system codes, such as the Normal / Secure Code or Open Code.
- Users who hold Secondary Codes can gain entry in any Mode of Operation.

Enrolling Primary and Secondary Codes

There are two methods to enroll Primary and Secondary codes, the Standard Method and the Code Search Method.

- The Standard Method is mainly used when the User Slot number for the user you wish to program is known. You can program both Primary and Secondary Codes using the Standard method. (See Enrolling Users with the Standard Method on Page 30)
- The Code Search Method is mainly used when enrolling a users Secondary Code and the User Slot Code is unknown. The Code Search method only works if a users Primary Code is already enrolled but the Secondary Code is not. (See Enrolling Users with the Code Search Method on Page 31)









Enrolling Primary and Secondary Codes using the Standard Method

- 1) Enter Programming Mode Mode   **Door**
GREEN
- 2) Press "7" to enter **Menu 7** Mode   **Door**
• The Door LED will turn orange ORANGE
- 3) Enter the 3-digit User Slot number ? ? ?
between 001 to 500 that you wish to enroll a Primary or Secondary code to.
For example, the User Slot 003 represents User #3.
- 4) a. If the selected slot has no Primary Code, the Mode LED will flash green, indicating that the controller is ready to accept a Primary Code. Mode   **Door**
GREEN GREEN
- b. If the selected slot already has a Primary Code but no Secondary Code, the Mode LED will flash red, indicating that the controller is ready to accept a Secondary Code. Mode   **Door**
RED GREEN
- c. If the selected slot already has a Primary and Secondary Code, you will hear a long beep and the controller will return to Normal Mode.
- 5) Enter the 4-digit PIN that you want to assign as the Primary or Secondary Code for this slot number.

If the PIN that is entered is valid the Mode LED will stop flashing and then the controller is ready for you to enter the next 3 Digit slot number (refer to step 3) that you want to assign a code to, or press the "#" key to move to the next slot number (refer to step 4). If you do not wish to continue enrolling codes, press the "#" key for 2 seconds and the controller will return to Normal Mode.

Enrolling Secondary Codes using the Code Search Method

The Code Search feature enables you to quickly enroll a Secondary Code to a user who already has a Primary Code.

- 1) Enter Programming Mode Mode   **Door**
GREEN
 - 2) Press "7" to enter **Menu 7** Mode   **Door**
• The Door LED will turn Orange ORANGE
 - 3) Enter the 3-digit User Slot number 000 0 0 0
• The Door LED will flash Orange Mode   **Door**
ORANGE
- The controller is now waiting for the Primary Code of the User you want to add a Secondary Code to.
- 4) Enter the 4 Digit PIN Code of the Primary Code belonging to the user you want to add a Secondary Code to.
• The Mode LED will flash red Mode   **Door**
RED ORANGE
- If the Primary Code entered is not valid, you will hear a long beep and the AC-S43 will continue to wait for a valid Primary Code.
- 5) Enter the 4-digit PIN Code to be used as the Secondary Code.

If the Secondary Code is valid the controller will beep three times and return to Normal Mode.

If the Secondary Code is invalid the controller will make a long beep and then the AC-S43 will continue to wait for a valid Secondary code to be entered.

Deleting Primary & Secondary Codes

There are two methods to delete Primary and Secondary codes, the Standard Method and the Code Search Method.

When deleting a User Slot, both the Primary Code and the Secondary code are erased.

Deleting Primary and Secondary Codes using the Standard Method

- 1) Enter Programming Mode Mode Door
GREEN
- 2) Press "8" to enter **Menu 8** Mode Door
RED ORANGE
 - The Mode LED will turn red
- 3) Enter the 3-digit User Slot codes you wish to delete.
 - The Mode LED will flash red indicating the controller is waiting for the Programming Code to confirm the deletion. Mode Door
RED ORANGE

If the User Slot is empty you will hear a long beep and the AC-Q42 will return to Normal Mode

- 4) Enter your Programming Code to confirm the deletion.

If the Programming Code is valid, you will hear three beeps and the AC-Q42 will return to Normal Mode.

If the Programming Code is invalid, you will hear a long beep and the AC-Q42 will return to Normal Mode.

Note: - It is recommended that a record be kept of added and deleted users so that it will be easier to keep track of which user slots are empty and which user slots are not.

Deleting Primary and Secondary Codes using the Code Search Method

- 1) Enter Programming Mode Mode Door
GREEN
- 2) Press "8" to enter **Menu 8** Mode Door
RED ORANGE
 - The Mode LED will turn red
- 3) Enter the 3-digit User Slot 000
 - The Door LED will flash orange Mode Door
RED ORANGE

The controller is now waiting for the Primary Code of the User you want to delete.

- 4) Enter the 4-digit PIN Code of the Primary Code belonging to the user you want to delete.
 - The Mode LED will flash red Mode Door
RED ORANGE

If the Programming Code is valid, you will hear three beeps and the AC-S43 will return to Normal Mode.

If the Programming Code is invalid, you will hear a long beep and the AC-S43 will return to Normal Mode.

Note: - It is recommended that a record be kept of added and deleted users so that it will be easier to keep track of which user slots are empty and which user slots are not.

Lock Strike Relay and Auxiliary Relay Code Assignment



When a Primary Code is enrolled for any user, that user is assigned rights to activate the Lock Strike Relay when they present a valid code to the controller. The Code Assignment Menu allows you to assign whether the Lock Strike Relay and/or the Auxiliary Relay is activated when a user enters a valid code



There are two methods to Assign Codes, Standard Method and the Code Search Method.

Lock Strike Relay and Auxiliary Relay Code Assignment using the Standard Method

1) Enter Programming Mode Mode   Door
GREEN



2) Press "9" to enter **Menu 9** Mode   Door
• The Mode LED will turn green GREEN ORANGE

3) Enter the 3-digit User Slot that you want to assign a code to.   

• The Door LED will flash green Mode   Door
GREEN ORANGE

4) Enter the assignment digit for the current User Slot:

- "1" assigns the Lock Strike Relay only
- "2" assigns the Auxiliary Strike Relay only
- "3" assigns the Lock Strike and Auxiliary Relay



• If the assignment code is valid the Mode LED will stop flashing. Mode   Door
GREEN ORANGE



The controller is now waiting for another slot number. Press the "#" key to go to the next slot or enter a new slot number, or if you do not wish to continue press the "#" key for 2 seconds and the controller will return to Normal Mode.

Lock Strike and Auxiliary Relay Code Assignment using the Code Search Method





1) Enter Programming Mode Mode   Door
GREEN



2) Press "9" to enter **Menu 9** Mode   Door
• The Mode LED will turn red GREEN ORANGE

3) Enter the 3-digit User Slot 000   

• The Door LED will flash orange Mode   Door
GREEN ORANGE

The controller is now waiting for the Primary Code of the user you want to Code Assign

4) Enter the 4-digit PIN Code of the Primary Code belonging to the user you want to assign a code to.    

• The Mode LED will flash green Mode   Door
GREEN ORANGE

5) Enter the assignment digit for the current User Slot:

- "1" assigns the Lock Strike Relay only
- "2" assigns the Auxiliary Strike Relay only
- "3" assigns the Lock Strike and Auxiliary Relay

If the assignment digit is valid, you will hear three beeps and then the controller will return to Normal Mode.

If the assignment digit is invalid, you will hear a long beep and the controller will wait for another assignment digit to be entered.

Return To Factory Default Settings

Warning:

You must be very careful before using this command! Doing so will erase the entire memory which includes all User and Special Codes, and return all codes to their factory default settings.

1) Enter Programming Mode



2) Press "0" to enter **Menu 0**

- The Mode LED will flash red
- The Door LED will flash red

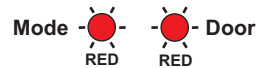

3) Enter your 4-digit Programming Code.



- If the Programming Code is valid, all memory will be erased, you will hear three beeps and the controller will return to Normal Mode
- If the Programming Code is invalid you will hear a long beep and the controller will return to Normal Mode without erasing the memory of the controller.

Replacing a lost Programming Code

Note: The AC-S43 must be in Normal Mode otherwise this will not work. Make sure that the Mode LED is green before proceeding.

- 1) Remove power from the AC-S43
- 2) Press the REX button
- 3) Apply power to the unit with REX button pressed
- 4) Release the REX button
- 5) You now have 15 seconds to program a new Programming Code into the unit using the initial default code 1234, before the controller reverts to the existing code.

Replacing a lost Normal / Secure Code

Note: The AC-S43 must be in Secure Mode otherwise this will not work. Make sure that the Mode LED is red before proceeding.

- 1) Remove power from the AC-S43
- 2) Press the REX Button
- 3) Apply power to the unit with REX button pressed.
- 4) Release the REX Button
- 5) You now have 15 seconds to program a new Normal / Secure code into the unit using the initial default code 3838, before the controller reverts to the existing code.

Glossary

A

Access Control: Primarily refers to a device or set of devices controlling the entry of people traveling through a door or set of doors.

Ajar Delay: The time allowed for a door to be left open before sounding an alert and / or activating the Auxiliary Relay.

Auxiliary Input: The term used for the programmable input electrical signal from an external device such as a Door Monitor switch or Auxiliary REX button.

Auxiliary Code: The four digit code used to activate the Auxiliary Output for testing purposes during installation.

Auxiliary Output: The term used for the Relay Output in the AC-Q43 that may be programmed to activate upon different system events such as Tamper, Forced Door Event, Door Ajar, etc.

B

Back Tamper: The electronic tamper signal advising the controller that the controller has been removed from the wall.

Bypass Code: The four digit code used to change the Mode of Operation of the AC-Q43 from Normal to Bypass Mode or vice versa.

Bypass Mode: A Mode of Operation where door access is not restricted to valid users. In this mode the door may be released by anyone pressing the bell button.

C

Case Tamper: The electronic tamper signal advising the controller that the case has been opened.

Code Assignment: The process of assigning which Output(s) (Lock Strike Relay and / or Auxiliary Relay) are to be activated when a valid code is entered.

D

Direct Shunt: The arrangement in which an external input (such as a door monitor) is connected directly to the Auxiliary Relay allowing the Auxiliary Output to be activated after the direct shunt delay elapses. This leaves the Auxiliary Input available for Normal / Secure mode toggle.

Default Factory Setting: The settings that the controller is preprogrammed with when the controller is manufactured.

Direct Shunt Delay: The delay time (user programmed) used in Direct Shunt (See Direct Shunt).

Door Bell: The alert sound activated when the door bell button on the AC-Q43 is pressed. (Requires the BL-D40 External Sounder)

Door Chime: The alert sound activated when the lock strike unlocks the door after a valid code has been presented. (Requires the BL-D40 External Sounder)

F

Fail Safe: The system setting in which a total power loss leaves the connected door unlocked.

Fail Secure: The system setting in which a total power loss leaves the connected door locked.

Forced Door: A door which has been physically opened without the access control device having released the lock.

Forced Door Time: The amount of time (user programmed) the controller waits in the event of a Forced Door before the Auxiliary Output is activated.

L

Lock Strike: Term used for the electronic or electromagnetic door lock used for locking or unlocking the door.

Lock Strike Release Time: The amount of time (user programmed) that the Lock Strike remains unlocked when a valid code is entered.

M

Master User: A user which has a Primary and Secondary Code which are the same, and can gain access in any Mode of Operation.

Mode of Operation: The state of operation of the controller. There are three "Modes": Normal Mode, Bypass Mode, and Secure Mode.

N

Normal Mode: The system setting (Mode of Operation) in which all valid users have access upon presenting a valid Proximity Card or PIN Code (Primary Code).

Normal / Bypass Code: The four digit code used to change the controllers Mode of Operation from Normal to Bypass Mode or vice versa.

Normal / Secure Code: The four digit code used to change the controllers Mode of Operation from Normal to Secure Mode or vice versa.

Normal User: A user who only has a Primary Code and can only gain access in Normal Mode.

Normally Closed: A relay output from the controller that is activated (closed circuit) under normal conditions.

Normally Open: A relay output from the controller that is de-activated (open circuit) under normal conditions.

O

Open Code: The four digit code used to activate the Lock Strike Relay for testing purposes during installation.

P

Primary Code: The unique code issued to enable access in Normal Mode. Users with only primary codes are Normal Users.

Programming Code: The four digit code required when entering programming mode, deleting users, and resetting the AC-Q43 to its factory default settings.

Programming Mode: The mode used when programming the AC-Q43's system settings.

R

Relay: An electronically controlled switch used for providing an Open Circuit or Closed Circuit output to external devices.

REX: An abbreviation of "Request To Exit".

Request To Exit (REX): Refers to a button which can release the door from inside. Commonly located at the reception desk, or near a door as an emergency door release.

S

Secondary Code: An additional code issued to enable access in Secured Mode. Users with non-identical Primary and Secondary Codes are Secure Users. Users with identical Primary and Secondary Codes are Master Users.

Secure Mode: The system setting (Mode of Operation) in which only valid Secure and Master Users have access upon presenting a valid code.

Secure User: A user which has a Primary Code and Secondary Code that are non-identical, and can gain access in any Mode of Operation.

Shunt: The arrangement in which an external input (such as a door monitor) is connected directly to the Auxiliary Input, allowing the auxiliary output to be activated after the Shunt Delay elapses. The auxiliary input will be unavailable for Normal / Secure Mode toggle.

Shunt Delay: Is the delay time (user programmed) used in Shunt (See Shunt).

Strike: See Lock Strike

T

Tamper Siren: The alert sound activated when a Back Tamper or Case Tamper event occurs. (Requires the BL-D40 External Sounder)

Tamper Siren Time: The time (user programmed) that the Tamper Siren will sound when activated.

Terminal Block: The rectangular connectors on the PCB used to attach wiring from external devices.

Limited Lifetime Warranty

ROSSLARE ENTERPRISES LIMITED'S (Rosslare) LIMITED LIFETIME WARRANTY is applicable worldwide. This warranty supersedes any other warranty. Rosslare's LIMITED LIFETIME WARRANTY is subject to the following conditions:

WARRANTY

Warranty of Rosslare's products extends to the original purchaser of the Rosslare product and is not transferable.

WARRANTY DURATION

Rosslare warrants this product against defects in material and/or workmanship for the life of the product from the date of original purchase to the original purchaser.

WARRANTY COVERAGE

Rosslare will repair or replace, at its option, any product which under normal conditions of use and service proves to be defective in material or workmanship. No charge will be made for labor or parts with respect to defects covered by this warranty, provided that the work is done by Rosslare or a Rosslare authorized service center. This warranty does not cover expenses incurred in the transportation, removal or reinstallation of the product, whether or not proven defective. Replacement or repairs furnished under this warranty are subject to the same terms and conditions of the original warranty.

EXCLUSIONS AND LIMITATIONS

Specifically excluded from this warranty are failures caused by abuse, neglect, misuse, improper operation, normal wear, accident, improper maintenance or modification. This warranty does not cover repair or replacement where normal use has exhausted the life of a part or instrument. Service life of the product is dependent upon the care it receives and the conditions under which it has to operate. In no event shall Rosslare be liable for incidental or consequential damages.

LIMITED LIFETIME WARRANTY TERMS

The terms of this warranty may not be varied by any person, whether or not purporting to represent or act on behalf of Rosslare. **This warranty represents the full extent of Rosslare's responsibility. Repair, replacement, or refund of the original purchase price, of the product is the exclusive remedy. This limited lifetime warranty is provided in lieu of all other warranties. All other warranties expressed or implied, including without limitation, implied warranties of merchantability and fitness for a particular purpose, are specifically excluded. In no event shall Rosslare be liable for damages in excess of the purchase price of the product, or for any other incidental, consequential or special damages, including but not limited to loss of use, loss of time, commercial loss, inconvenience, and loss of profits, arising out of the installation, use, or inability to use such product, to the fullest extent that any such loss or damage may be disclaimed by law.** This warranty shall become null and void in the event of a violation of the provisions of this limited warranty.

Technical Support

International Web Site:

www.rosslare.com.hk/support/

Asia, Australia, & South America:

Rosslare Enterprises Ltd.
905-912 Wing Fat Industrial Bldg.,
12 Wang Tai Road, Kowloon Bay,
Hong Kong.

Tel: (852) 2795 5630
Fax: (852) 2795 1508
E-mail: info@rosslare.com.hk

Europe, Russia, Middle East, Africa:

Rosslare Security Products S.r.l
Via F.lli Gabba 5, 20121 Milano, Italy

Tel: (39) 0382 24800
Fax: (39) 0382 24800
E-mail: marco.rogante@tin.it
rosslarect@aol.com

United States and Canada:

Rosslare NAPDC
Suite 238, 200 East Howard Street,
Des Plaines, IL 60018
USA
Web Site: www.rosslaresecurity.com
Tel: (847) 827 6330
Fax: (847) 827 6433
E-mail: support@rosslare.net