

NVR H series

Network video recorders with HDMI output



Product versions

NVR HAC (8-ch)	NVR HAC (16-ch)
up to 8 channels	up to 16 channels
NVR HDC (8-ch)	NVR HDC (16-ch)
up to 8 channels	up to 16 channels
powered by a low-voltage power supply	powered by a low-voltage power supply

Ajax network video recorders integrate Ajax video devices and third-party IP cameras into a single ecosystem. In addition to in-app control, NVR H series devices feature an HDMI output that enables users to view live and archived footage directly on a connected display. This makes the series an ideal solution for small to medium-sized businesses, private residences, offices, and other sites requiring a local video management system.

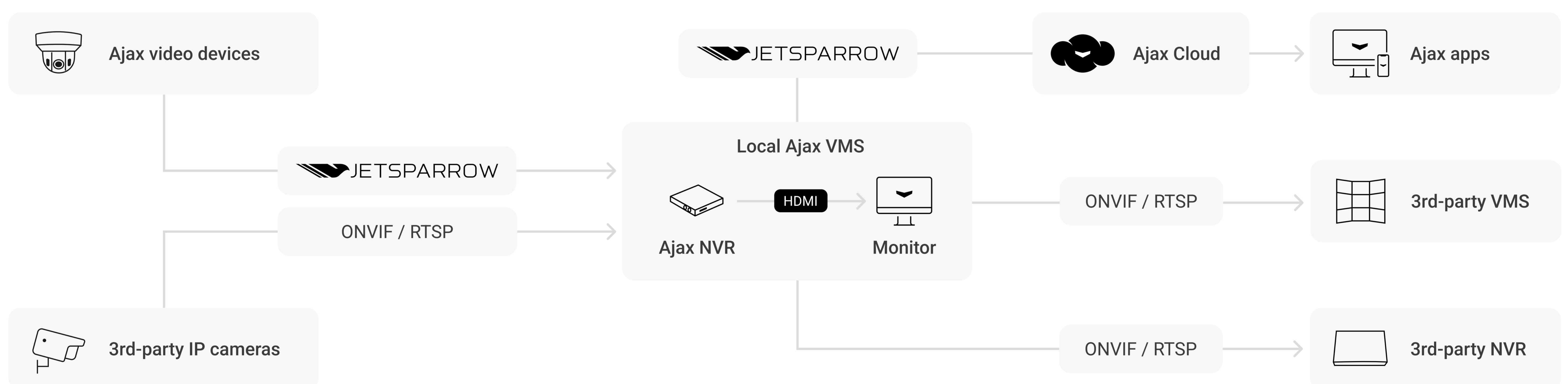

Local video management experience

- On-site video surveillance without an internet connection¹
- Local video management and archive access
- Customizable virtual video wall and slideshow mode
- HDMI port for connecting a display
- Two USB ports for a keyboard, mouse, or flash drive

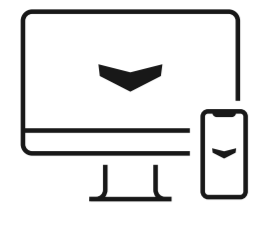

Remote video management via Ajax apps

- Proprietary JetSparrow technology for instant, encrypted video streaming and smooth archive navigation
- Archive synchronization with security system events
- High-resolution visual verification of alarms via video scenarios
- Instant transition from notifications to on-site video recordings
- Fast archive navigation using event timeline, calendar view, and search filters

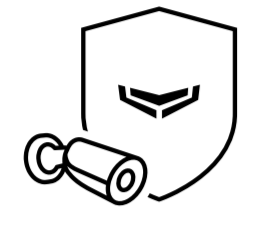

Robust security without privacy compromises

- TLS-encrypted video streams
- User-controlled access to video content
- Passwordless camera authentication
- Secure video export with digital signature verification
- Multi-tiered account protection: passcodes, biometrics, and two-factor authentication
- Session control for additional account safety
- Exclusive owner access to content stored on the hard drive
- NDAA compliance

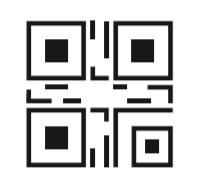

Easy installation and maintenance

- SmartBracket for fast and secure installation
- Adding to an Ajax system via QR code
- Remote control and configuration via Ajax apps
- Configurable motion detection zones for connected cameras
- Support for ONVIF/RTSP authorization
- Automatic search for available cameras on the local network
- Real-time NVR health monitoring, including HDD state

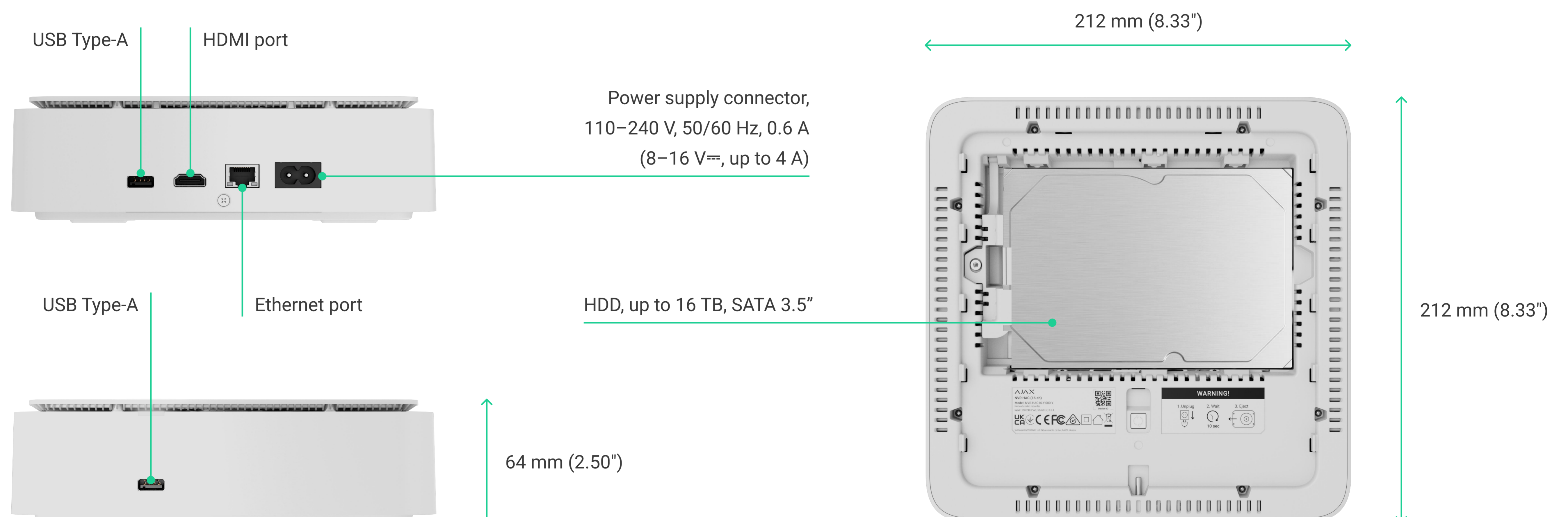

HDMI cable and HDD are not included in the complete set.



<p>Video stream</p> <p>IP cameras ONVIF² RTSP</p> <p>Storage hard drive with up to 16 TB capacity (SATA connectivity, 3.5" size) HDD is not included in the complete set</p> <p>Decoding formats H.265/H.264</p> <p>Bandwidth incoming: up to 80 Mbps outgoing: up to 40 Mbps</p>	<p>Ports</p> <p>Full HD HDMI</p> <p>Ethernet RJ45</p> <p>USB 2 × USB Type-A To connect an interface device (e.g., mouse, keyboard, etc.) or a flash drive</p>	<p>Key features</p> <p>JetSparrow Proprietary Ajax protocol for fast and secure video transmission</p> <p>Motion detection Built-in software to detect movement in the frame</p> <p>Built-in video management system</p> <p>Visual verification of system alarms</p>																										
<p>Installation</p> <p>Operating temperature 0 °C to +40 °C 32 °F to 104 °F</p> <p>Operating humidity up to 75%</p> <p>Protection class IP20</p>	<p>Enclosure</p> <table border="0"> <tr> <td>Dimensions</td> <td>Colors</td> </tr> <tr> <td>212 × 212 × 64 mm 8.33" × 8.33" × 2.50"</td> <td>black, white</td> </tr> <tr> <td>Weight</td> <td></td> </tr> <tr> <td>NVR HAC (8-ch) NVR HAC (16-ch)</td> <td>NVR HDC (8-ch) NVR HDC (16-ch)</td> </tr> <tr> <td>782 g 27.6 oz</td> <td>752 g 26.5 oz</td> </tr> <tr> <td>Without a hard drive</td> <td>Without a hard drive</td> </tr> </table>	Dimensions	Colors	212 × 212 × 64 mm 8.33" × 8.33" × 2.50"	black, white	Weight		NVR HAC (8-ch) NVR HAC (16-ch)	NVR HDC (8-ch) NVR HDC (16-ch)	782 g 27.6 oz	752 g 26.5 oz	Without a hard drive	Without a hard drive	<p>Complete set</p> <table border="0"> <tr> <td>For NVR HAC</td> <td>For NVR HDC</td> </tr> <tr> <td>NVR</td> <td>NVR</td> </tr> <tr> <td>SmartBracket mounting panel</td> <td>SmartBracket mounting panel</td> </tr> <tr> <td>Power cable</td> <td>Terminal adapter</td> </tr> <tr> <td>Ethernet cable</td> <td>Ethernet cable</td> </tr> <tr> <td>Installation kit</td> <td>Installation kit</td> </tr> <tr> <td>Quick start guide</td> <td>Quick start guide</td> </tr> </table>	For NVR HAC	For NVR HDC	NVR	NVR	SmartBracket mounting panel	SmartBracket mounting panel	Power cable	Terminal adapter	Ethernet cable	Ethernet cable	Installation kit	Installation kit	Quick start guide	Quick start guide
Dimensions	Colors																											
212 × 212 × 64 mm 8.33" × 8.33" × 2.50"	black, white																											
Weight																												
NVR HAC (8-ch) NVR HAC (16-ch)	NVR HDC (8-ch) NVR HDC (16-ch)																											
782 g 27.6 oz	752 g 26.5 oz																											
Without a hard drive	Without a hard drive																											
For NVR HAC	For NVR HDC																											
NVR	NVR																											
SmartBracket mounting panel	SmartBracket mounting panel																											
Power cable	Terminal adapter																											
Ethernet cable	Ethernet cable																											
Installation kit	Installation kit																											
Quick start guide	Quick start guide																											
<p>Power supply</p> <table border="0"> <tr> <td>NVR HAC (8-ch), NVR HAC (16-ch)</td> <td>NVR HDC (8-ch), NVR HDC (16-ch)</td> </tr> <tr> <td>Main 110–240 V, 50/60 Hz, 0.6 A</td> <td>Without an installed jumper on the PSU board 8–16 V$\overline{=}$, up to 4 A</td> </tr> <tr> <td>Power consumption up to 24 W</td> <td>With an installed jumper on the PSU board 12.1–16 V$\overline{=}$, up to 4 A</td> </tr> <tr> <td></td> <td>Power consumption up to 24 W</td> </tr> </table>			NVR HAC (8-ch), NVR HAC (16-ch)	NVR HDC (8-ch), NVR HDC (16-ch)	Main 110–240 V, 50/60 Hz, 0.6 A	Without an installed jumper on the PSU board 8–16 V $\overline{=}$, up to 4 A	Power consumption up to 24 W	With an installed jumper on the PSU board 12.1–16 V $\overline{=}$, up to 4 A		Power consumption up to 24 W																		
NVR HAC (8-ch), NVR HAC (16-ch)	NVR HDC (8-ch), NVR HDC (16-ch)																											
Main 110–240 V, 50/60 Hz, 0.6 A	Without an installed jumper on the PSU board 8–16 V $\overline{=}$, up to 4 A																											
Power consumption up to 24 W	With an installed jumper on the PSU board 12.1–16 V $\overline{=}$, up to 4 A																											
	Power consumption up to 24 W																											

¹ To ensure continued offline operation, cameras added via an Ajax NVR must connect to the Ajax Cloud server at least once every 30 days.

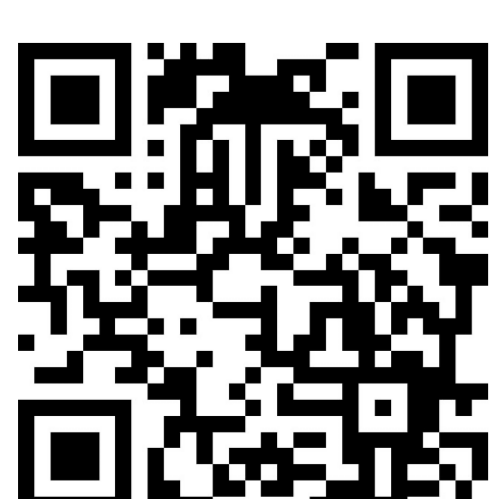
² NVR H series devices support ONVIF Profile S, as well as some features of Profiles T and M.



For detailed information, scan the QR code or follow the link:
ajax.systems/support/devices/nvr-h

-  support@ajax.systems
-  @AjaxSystemsSupport_Bot
-  ajax.systems