



Ditec

IP2173EN • 2021-02-18



Ditec DAB105 - DAB205

User manual

(Translation of the original instructions)

Instruction for safe operation



- Failure to observe the information in the user manual may result in personal injury or damage to equipment.
- To reduce the risk of injury to persons - use this operator with single or double pedestrian swinging or folding doors only.
- Do not use the equipment if repair or adjustment is necessary.
- Disconnect supply when cleaning or other maintenance is to be carried out.
- The operator can be used by children age 8 and above, and persons with reduced physical, sensory or mental capabilities, or lack of experience and knowledge, if they have been given supervision or instruction by a person responsible for their safety concerning safe operator use and the possible hazards involved.
This does not however prevent those persons to use the door where the operator is installed.
- Cleaning and user maintenance shall not be made by children without supervision.
- Do not let children climb on or play with the door or the fixed/remote controls.

Electronic equipment reception interference

The equipment complies with the European EMC directive, provided installed according to Installation and Service manual.

The equipment may generate and use radio frequency energy and if not installed and used properly, it may cause interference to radio, television reception or other radio frequency type systems.

If other equipment does not fully comply with immunity requirements interference may occur.

However, there is no guarantee that interference will not occur in a particular installation. If this equipment does cause interference to radio or television reception, which can be determined by turning the equipment off and on, the user is encouraged to try to correct the interference by one or more of the following measures:

- Re-orient the receiving antenna.
- Relocate the receiver with respect to the equipment.
- Move the receiver away from the equipment.
- Plug the receiver into a different outlet so that equipment and receiver are on different branch circuits.
- Check that protective earth (PE) is connected.

If necessary, the user should consult the dealer or an experienced electronic technician for additional suggestions.

Product liability

According to regulations, the following are the responsibility of the owner or caretaker of the equipment

- that the equipment operates correctly, so that it gives sufficient protection in regard to safety and health
- that the equipment is operated and regularly maintained, inspected and serviced by someone with documented competence in the equipment and in applicable regulations
- that a journal is kept of inspection, maintenance and service records including the provider
- that inspection covers the emergency opening function (when applicable)
- that the closing force is appropriate for the door size on fire-approved door systems (when applicable)

Service

Regular inspections by a trained and qualified person, and the frequency of service occasions, should at minimum be made according to national regulations or industry standard, in the absence of a national regulation. This is especially important when the installation concerns a fire-approved door or a door with an emergency-opening function. To extend the life of your investment and ensure safe and reliable operation of the door, we recommend a minimum of 2 visits per year or more, depending on usage and operating conditions. Environmental aspects shall also be considered.

Intended use

The Ditec DAB105 / Ditec DAB205 is an automatic swing door operator developed to make life easier for everyone who can benefit from automatic doors.

The Ditec DAB105 / Ditec DAB205 is a low-energy as well as a full power operator using a DC motor and a gear-reduction system to drive an arm system, which opens the door.

It is to be installed indoors where it is suitable for almost all types of external and internal swing doors.

This widely-used operator can be found on applications ranging from handicapped access in private homes to high-traffic retail operations.

For installation and maintenance see Installation and Service manual Ditec DAB105 IP2159 / Ditec DAB205 IP2178.

Save these instructions for future reference.

How the Ditec DAB105 / Ditec DAB205 works

The swing door operator Ditec DAB105 / Ditec DAB205 uses a DC motor and a gear-reduction system to drive an arm system which opens the door. Closing power is provided by a motor and a clock spring. A highly sophisticated electronic control unit uses a motor encoder and a microprocessor to control the door's movement.





To activate the operator you can use a manual activator (elbow switch) or an automatic activator (radar device). It is also possible – where local standards allow – to activate the operator by just pushing the door, if Push & Go is selected.

After the door has been activated it will open and stay open for a specified Hold Open Time (HOT).

When the HOT has elapsed the door will close.

The Ditec DAB105 / Ditec DAB205 can be set in three or four different modes, depending on programme selector type, see table below.

In fully manual use (or in case of a power failure) the Ditec DAB105 / Ditec DAB205 acts as a normal door closer.

Position	Function
	AUTO Normal position The door can be opened with the inner and outer manual and/or automatic activators. The electric strike, if fitted, is open.
	OFF The door is closed. The door cannot be opened with inner and outer activation units. The door is locked if an electromechanical locking device has been fitted. The door can be opened with a key switch (if fitted).
	OPEN The door is held permanently open by the motor.
	EXIT Passage from inside only. The door is normally locked if an electromechanical locking device has been fitted. The door can only be opened with the inner activation unit and with a key switch (if fitted).

Technical specification











	DAB105	DAB205
Mains power supply:	100-240V AC +10/-15%, 50/60Hz	
Power consumption:	max 75W	max 300W
Class of protection:	IP20	

Regular safety checks

To help you fulfil the national/international requirements and to avoid malfunction and risk for injuries, we have provided the following checklist.

Do not use if repair or adjustment is necessary.

Disconnect supply [14] when cleaning or other maintenance is to be carried out.

Daily Action		If problems occurs	
Activate your operator and check visually, fastening of <ul style="list-style-type: none"> • operator 1 • arm system 2 • cables 3 • programme selectors 4 • hinges 5 • door and glass 6 			
Also inspect your operator and check visually for <ul style="list-style-type: none"> • sharp edges on the door leaf and door frame (if any) 7 • condition of door seals 8 • finger protection 9 • and finally that the complete door runs properly and closes slowly in a smooth way 		 	
Set the programme selector to OFF and check that the operator and electromechanical lock (if fitted) work together. Also check that the lock 10 really secures the door.			
Activate the manual activation units 11 , if any, and walk towards the door. Check that the door has opened appropriately while you pass the entrance/exit. Then proceed with the automatic activation units 12 in the same way.			
Check the non-monitored safety sensors 13 if any, by standing in the swing path and activate the operator. The door must not hit you when opening nor when closing. If you are unsure of which type of sensor you have, please contact your Ditec representative.			
Escape doors	By law, these tests must be performed regularly by trained personnel.	Set the programme selector in AUTO mode. Push the door manually in escape direction and make sure that no object or function will prevent the door from opening. Also make sure the escape route is free for use.	 
Fire doors		Let the door close after an impulse ensuring nothing prevents the door from closing and locking (if regulations require it).	 

 = take appropriate measures.

 = contact the Ditec Customer Technical Service.

Function and visual inspection

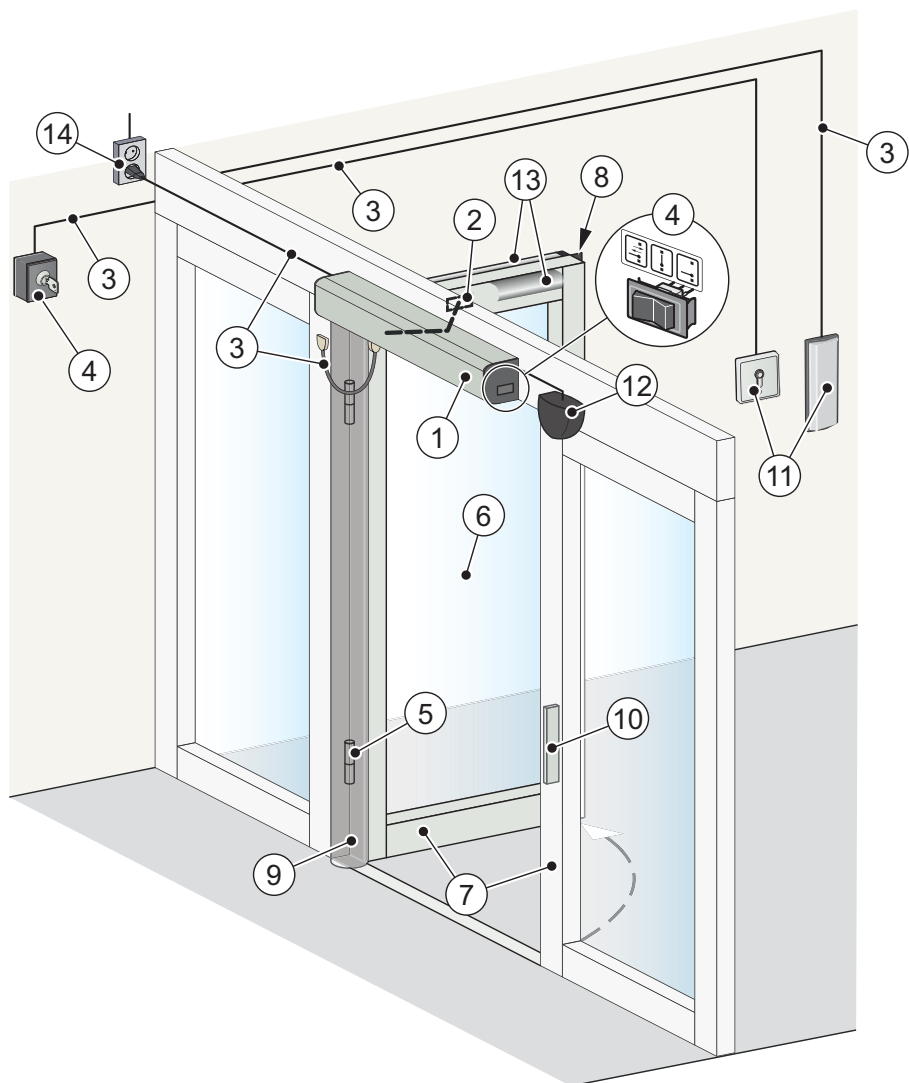

Cleaning





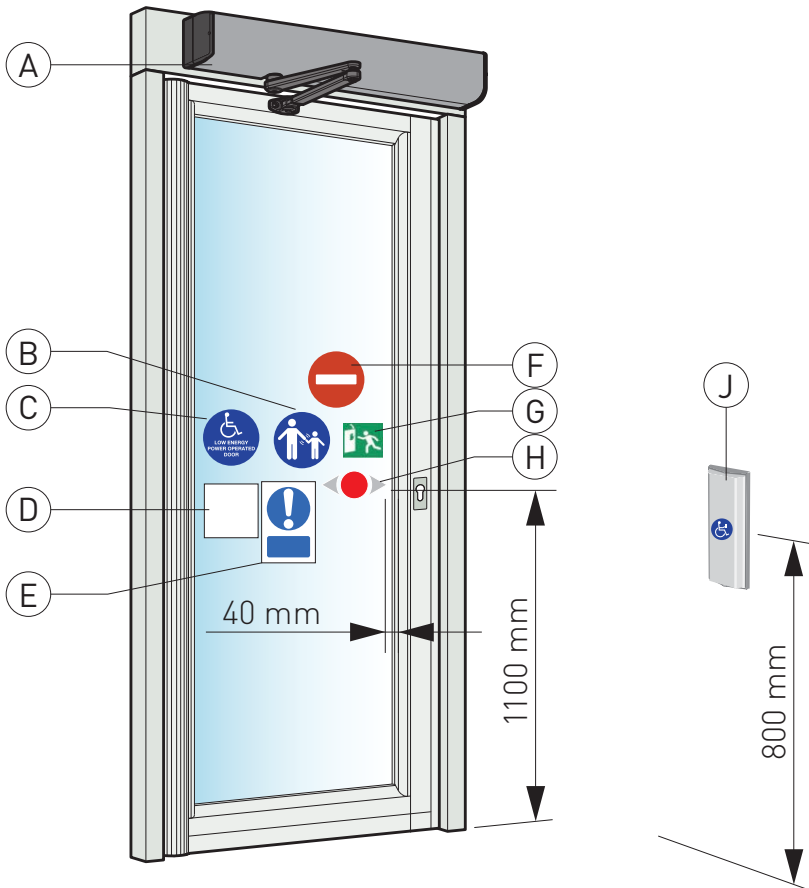

The best way to remove dust and dirt from the Ditec DAB105 / Ditec DAB205 is to use water and a soft cloth or a sponge. A gentle detergent may be used. To maintain the quality of the enamel layer, the surfaces should be cleaned once/four months period. The cleaning should be documented. To avoid damages to the profiles the brushes/ weather stripping must be vacuum-cleaned weekly.

- Do not expose windows, doors or profiles to alkalis. Both aluminium and glass are sensitive to alkalis.
- Do not clean with high pressure water. Operator, programme selector and sensor may be damaged and water may enter the profiles.
- Do not use polishing detergent.
- Do not scrub with materials like Scotch-brite, as this will cause mechanical damage.

Signage



Check that all required signage is applied and intact. Mandatory indicates that the signage is required by European directives and equivalent national legislation outside the European Union.

Ref.		Description	
A		Product label. Mandatory.	
B		Supervision of child. Mandatory, if applicable. Apply to both side of the door. To be placed on entrances where risk analysis shows use by children, elderly and disabled.	
C		Operator designed for disabled people. Raccomended, if applicable (applied to both sides of the door)	
D		Automatic door. Only mandatory in GB.	
E		Keep clear. Only mandatory in GB.	
F		No entry. Identifying one-way traffic. Mandatory in GB and US. If applicable.	
G		Emergency break-out. Mandatory, if approved for escape route.	
H		Door sticker. Mandatory, if applicable to highlight the presence of the glass (applied to all glass sections that are moving).	
J		Activation by disabled people. Recommended, if applicable.	

 Contact the Ditec Customer Technical Service.

General accessories

Your Ditec DAB105 / Ditec DAB205 can be further improved with the following add-ons (please contact your local Ditec company for detailed description).

- Position switch 4 , see page 7.
- Electrical lock 10 , see page 7.
- Key switch 11 , see page 7.
- Elbow switch 11 , see page 7.
- Radar 12 , see page 7.
- Wireless transmitters (not illustrated)
- Access control (not illustrated)
- Door stop (not illustrated)

Safety accessories

Even though the Ditec DAB105 / Ditec DAB205 is installed to comply with all applicable safety regulations, it is possible to enhance safety/comfort with the following add-ons (please contact your local Ditec representative for detailed description).

- Safety sensors 13 , see page 7.
- Finger protection 9 , see page 7.

Troubleshooting

What 's wrong?	Remedies
The door does not open	
The motor does not start	Change the setting of the program selector. (See page 5). Check that there are no objects in the detection zone if a sensor is fitted. Check the mains switch and fuse in the building.
The motor starts but door(s) will not open	Unlock the mechanical locks. Check that nothing is jammed beneath the door.
The door does not close	
	Change the setting of the program selector. (See page 5). Check that there are no objects in the detection zone if a sensor is fitted. Check that nothing is jammed beneath the door.
The door opens and closes continuously	Check that there are no moving objects within 1-1.5 m (39"-59") from the door if an automatic activation unit is fitted.

If the problem persists, contact the Ditec Customer Technical Service.

All rights related to this material are the exclusive property of ASSA ABLÖY Entrance System AB. Although the contents of this publication have been compiled with the greatest possible care, ASSA ABLÖY Entrance System AB cannot accept liability for any damage that might arise from errors or omissions in this publication. We reserve the right to make modifications without prior notice. No part of this publication may be copied, scanned, adapted or modified without prior permission in writing from ASSA ABLÖY Entrance System AB.

 The crossed-out wheeled bin symbol indicates that the product should be disposed of separately from household waste. The product should be handed in for recycling in accordance with local environmental regulations for waste disposal. By separating a marked item from household waste, you will help reduce the volume of waste sent to incinerators or landfill and minimize any potential negative impact on human health and the environment.

