

TAKEX BATTERY OPERATED FLAME SENSOR

TX-124R

Instruction Manual

We appreciate your purchase of a TAKEX flame sensor. This sensor will provide long and dependable service when properly installed. Please read this Instruction Manual carefully for correct and effective use.

Please note : This sensor is designed to detect flames and to initiate an alarm. It is not a fire-preventing device.

TAKEX is not responsible for damage, injury or losses caused by accident, theft, natural disasters (including inductive surge by lightning), abuse, misuse, abnormal usage, faulty installation or improper maintenance.

1 PRODUCT DESCRIPTION

The flame sensor TX-124R detects ultraviolet rays contained in flames and activates an external output. It can be installed either indoors or outdoors. Selecting the setting that is best suited to the environment the sensor is installed in from the 8 types will reduce the possibility of false detection of other kinds of ultraviolet rays.

The TX-124R is a low current consumption device that is designed to be equipped with a wireless transmitter in the back box.

Please confirm that this unit matches with the transmitter to be used. Some transmitters may not perceive the output of this unit.

2 PARTS DESCRIPTION

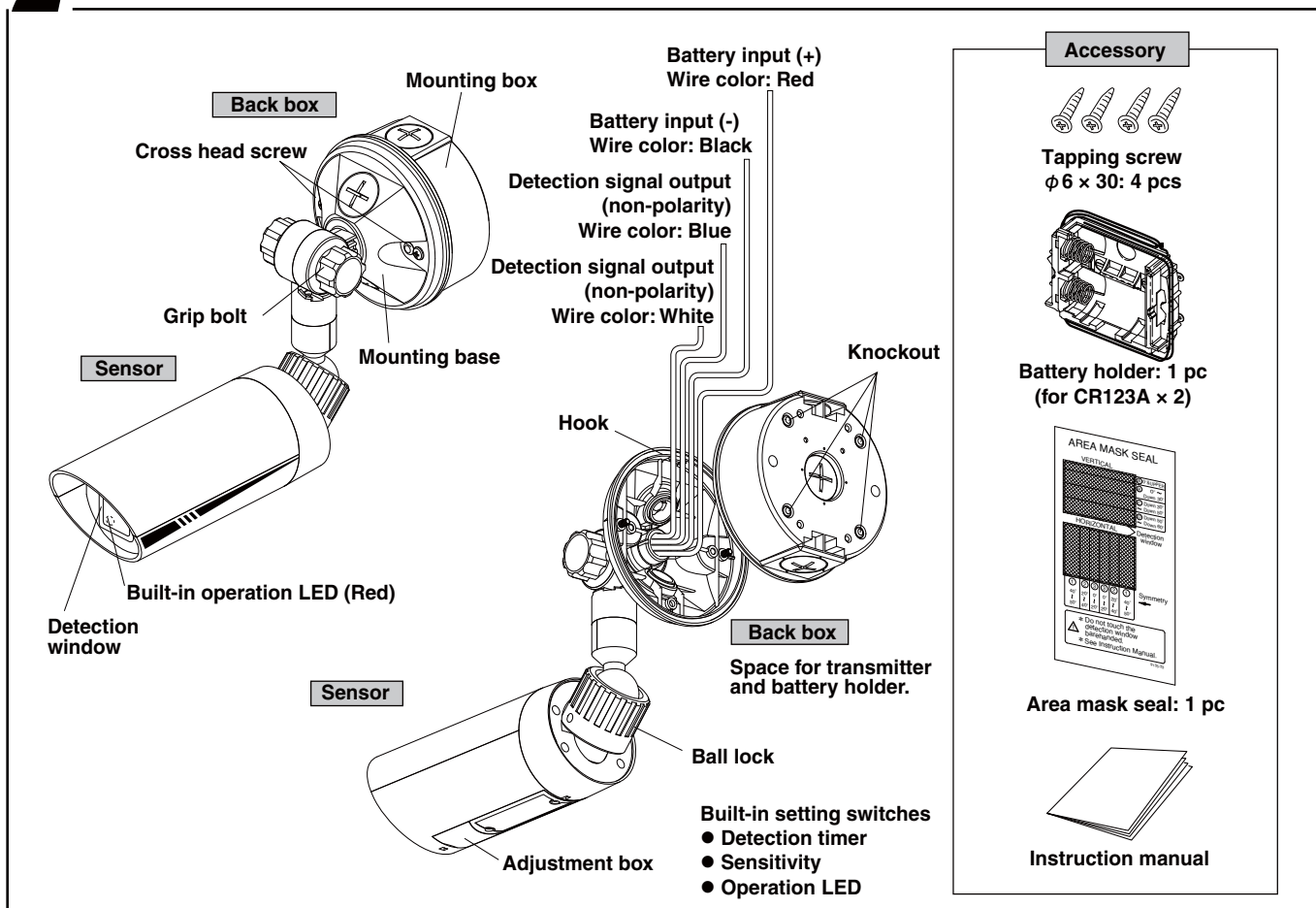

CAUTION

* Follow the voltage of the indicated power supply. Incorrect voltage may cause fire, electric shock, etc.

* Do not connect equipment that exceeds the indicated output capacity. It may cause fire.



CAUTION

* Do not install in locations that cannot withstand the weight of this product. It may fall and cause an accident.

* Do not disassembly or modify this product. This may cause fire, electric shock, etc.



3 PRECAUTIONS

PRODUCT CLASSIFICATION

This sensor is designed to detect ultraviolet rays contained in flames and to issue a signal. This unit is not a fire-preventing device. It will not detect smoke or heat. TAKEEX is not responsible for damage, injury or losses caused by fire, accident, calamity, natural disasters (including inductive surge by lightning), abuse, misuse, abnormal usage, faulty installation or improper maintenance.

INSTALLATION

- The unit is designed for ceiling and wall mounting. Please make sure the base surface is protected with reinforcements. In case of installation on concrete or gypsum board, please use anchors and screws suitable for the material.
- Keep the sensor angle somewhere between completely horizontal and completely vertical when installed outdoors.

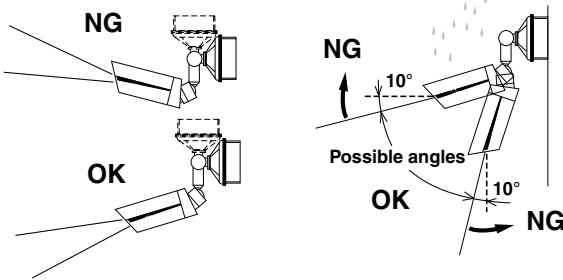

- Keep the detection window straight and the adjusting part at the bottom.

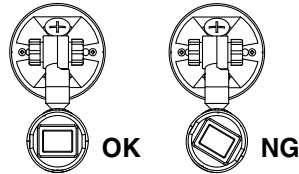

- Do not pour water directly on the sensor. (It is rain proof, but not water tight.)
- Do not install the unit in locations where high amounts of steam stagnate (bathrooms etc.).
- Do not install the unit in areas where the temperature is under -20°C (-4°F) or over $+50^{\circ}\text{C}$ ($+122^{\circ}\text{F}$).
- Do not install the unit in an environment subject to electrical noise or intense vibration.
- After adjusting the angle, tighten the screws and bolts to prevent the unit from falling and to maintain resistance to rain.
- A high installation location is recommended to prevent vandalism. (over 2.5m)
- This product is for installation on walls, ceilings, and under eaves. Use the optional attachment for installation at uneven places.

OTHERS

- The detection window is made of specialized glass and is fragile.
- Do not touch the detection window barehanded. Oil from hands may cause low sensitivity. Wipe the detection window with a soft cloth with alcohol if it is dirty. After installation, wipe again when necessary.

OBJECTS TO BE DETECTED

- This sensor detects ultraviolet rays at a very sensitive level, so it will possibly detect objects other than flames. In addition, this sensor does not detect burning objects that are not producing flames.

- Ultraviolet rays are invisible. They may be released from unexpected objects. Set the sensitivity to "L" and the detection timer to the next longer time when the sensor does not operate properly, such as generating an alarm when there is no flame or when none of the "possible causes of false alarm" listed below are present.
- In the case of an explosion, the sensor may be damaged before detecting flames.

Possible cause of false alarm. Do not install the sensor near the following:	Flames which can not be detected:
<ul style="list-style-type: none"> * Halogen lamp * Electric discharge lamp such as a mercury lamp * Electric sterilizer lamp * Welding sparks * Electric sparks (caused by motor, pantograph) * Sunlight * Electric discharge from lightning * Radiation * High electrical field 	<ul style="list-style-type: none"> * Flames through glass or transparent resin * Lit portion of cigarette * Burning charcoal or briquet * Electric stove * Burning object without flames

- Sparks from areas nearby where welding is being performed may cause false detection.



- If a person who is undergoing isotope therapy (radioiodine therapy) comes near the unit, they may emit radiation sufficient to trigger the sensor. Set the sensitivity to "L" in cases where such persons may be near the sensor.
- Do not install the unit in locations where sparks or flames are usually used (kitchen, incinerator, etc.).
- Do not install the unit in locations subject to severe shock or electric noise.
- Do not install the unit in locations where a shield object (glass, transparent resin, etc.) is in front of the sensor.
- Do not install the unit near high voltage power lines. Sparks from pylons may cause false detection.
- Do not install the unit near railways. Sparks from pantographs may cause false detection.

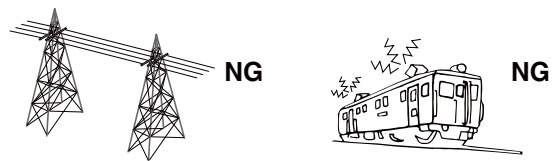

- * There are many other ultraviolet rays in outdoors that may cause unexpected detection. Therefore, it is recommended that the detection timer be set to longer than 6 sec. when the unit is installed outdoors.

INSTALLED OUTDOORS 	DETECTION TIMER	1 sec.: Not recommended 6 sec. or more: OK
	SENSITIVITY	H: Not recommended L: OK

(The factory setting is 6 sec.)

- The sensitivity will decrease in cases of rain or snow in the detection area.
- In cases where the detection window is covered with frost, ice, etc., the sensitivity will become very low and the sensor may not detect properly.

4 DETECTION AREA

- The detection distance depends on the size and duration of the flame. Bigger flames with longer durations can be detected at longer distances. Smaller flames with shorter durations can only be detected at shorter distances.

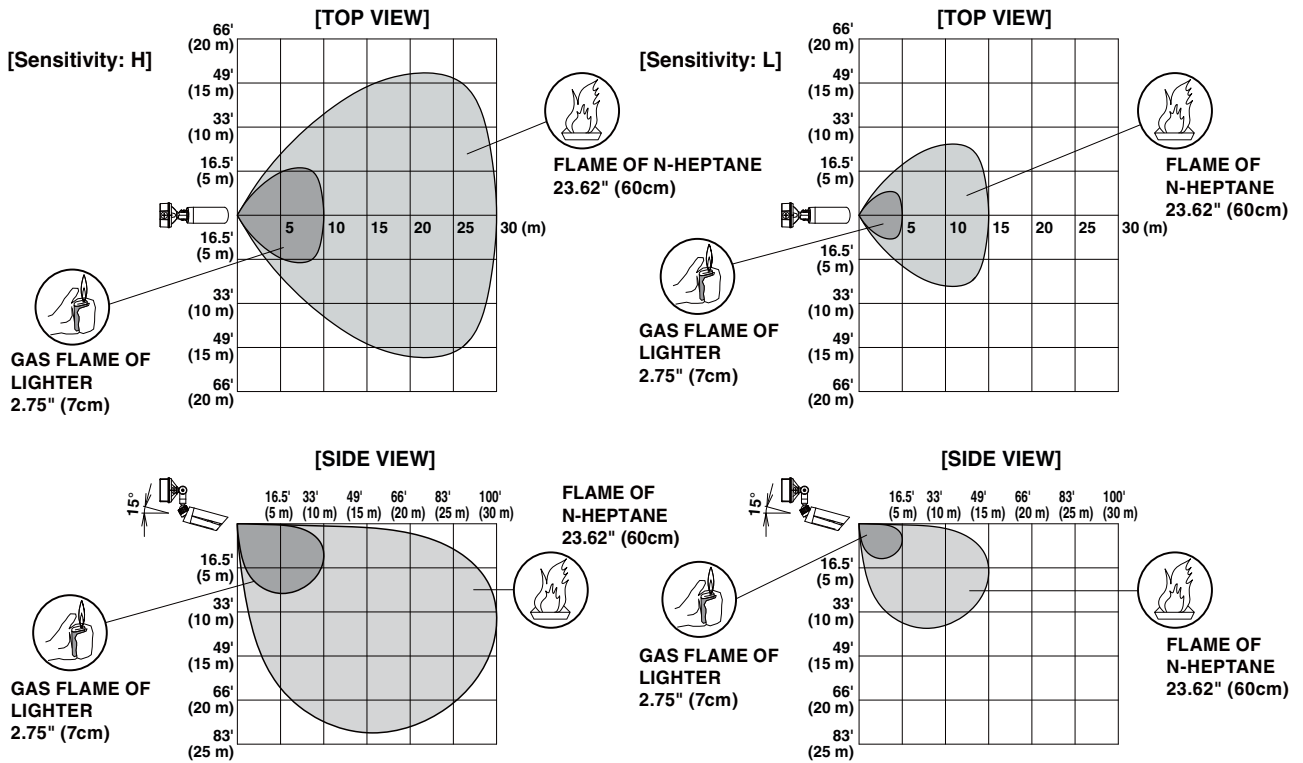

* [N-HEPTANE FLAME]: Flame that burns the flammable liquid "n-heptane" that is a component of gasoline. Takenaka uses this flame as the standard flame for measurement. Flame size fluctuates, so the above detection areas are averages.

AREA MASKING

- There are many ultraviolet rays in outdoors that may cause unexpected detection. In case there are objects in the area that cause unexpected detection that cannot be avoided through adjustment, use the accessory "area masks" to cover the area.
- There are 6 horizontal masks and 4 vertical masks. These 2 types can also be used in combination.
- Affix the area mask on the edge of the detection window while holding the tab, and tear off the tab after affixing the area mask.
- After affixing the area mask, check operation of the sensor.
- Wear gloves and do not touch the detection window barehanded.

AREA MASK SEAL

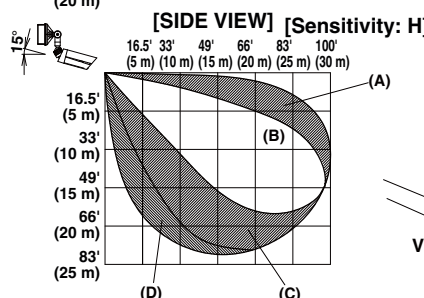
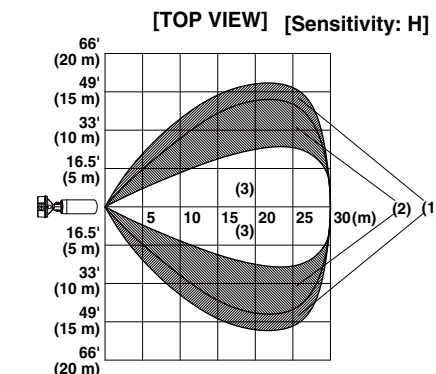
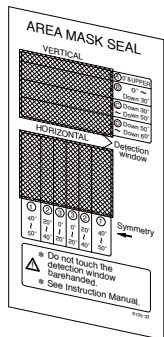

AREA MASK SEAL

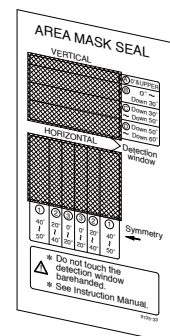

5 WIRING

⚠ WARNING

- ⚠ Use a common battery for TX-124R and a transmitter.
- ⚠ When inserting or replacing batteries, be sure to use two new batteries. Do not mix used and new batteries.
- ⚠ Use CR123A lithium batteries only!

(1) Take the 2 screws (cross head screws) off the mounting base and detach the mounting box.

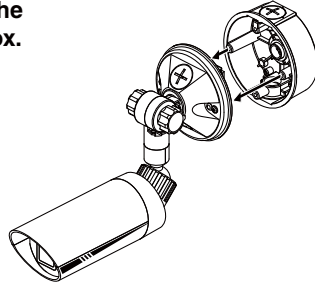

(2) Connect the 4 wires from the sensor to the battery and terminals of the transmitter.

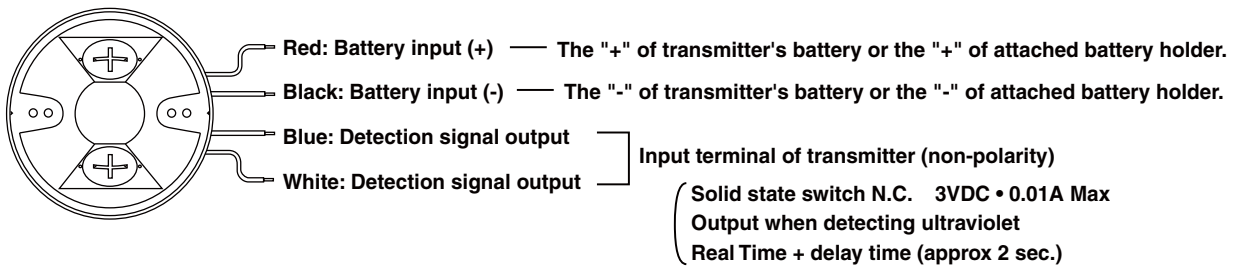

● Battery input

Connect battery as follows.

- a) Share the battery of the transmitter. b) Share 2 × CR123A battery using attached battery holder.

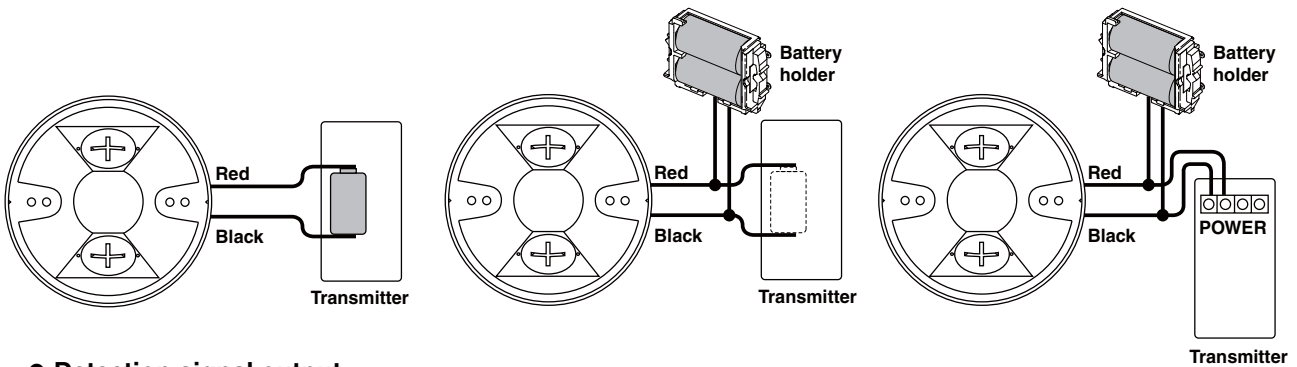

● Detection signal output

Connect the detection signal output to the transmitter.

The detection output signal from the sensor is N.C.
 It is a non-polarity signal. Please connect the transmitter directly.
 When the sensor detects something, the output signal changes to OPEN.

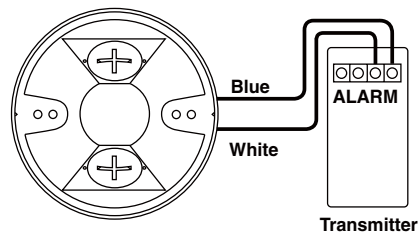

(3) Store the transmitter and battery in the mounting box and fasten the screws.
 (Ref.: 6. INSTALLATION)

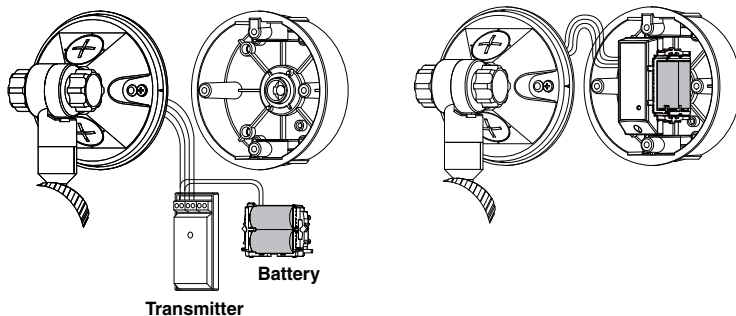

(4) After connecting the transmitter, please check operation.

6 INSTALLATION

1) Select the most suitable installation position and method according to the purpose.

- The detection area can be adjusted to have a wide angle which allows the sensor to be installed in various locations.
- Loosen the Grip bolt and ball lock and refer to section 3 when installing. Do not forget to tighten then lock when the installation is finished.

 The direction of rotation of the left and right grip bolts is the same. Please do not rotate each in the opposite direction. Please refer to the direction of rotation described on the body sticker.

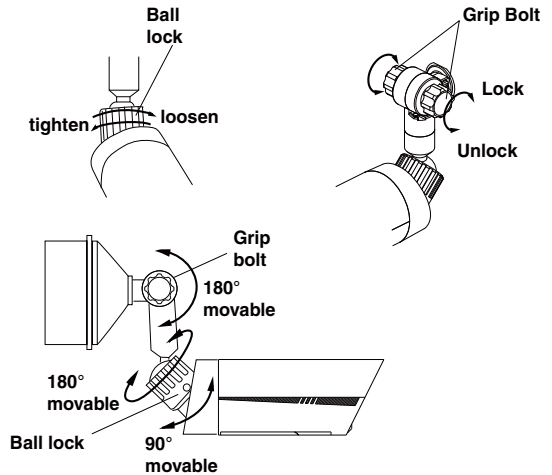

2) Loosen the 2 screws (Cross head screw) and take the mounting base off from the mounting box.

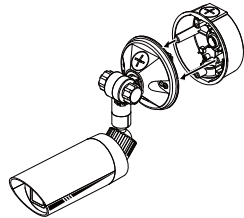

3) Make a hole through knock out in the mounting box, and fix the mounting box by attaching the tapping screws to the surface.

(In case of wall mount, the hook should point upwards. For ceiling mount, the hook should point towards the detection area.)

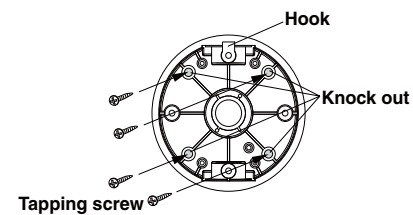

4) Fit the projection on the mounting base to the hook on the mounting box, then fix the mounting base to the mounting box using 2 screws.

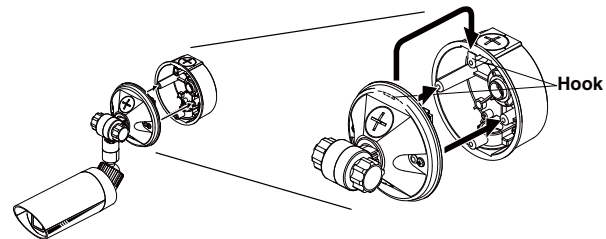

5) Set the sensor up temporarily and then check the detection area and its operation.

Make sure the detection window is pointing lower than the horizontal, refer to "Precautions" and "Detection Area", and then fix it in place.

CAUTION

If the sensor is subjected to a strong impact, damage may be caused to the sensor, the sensor may malfunction, or the sensor's performance may be reduced. Do not handle the sensor a rough manner.

7 OPERATION CHECK

Check how the sensor operates after wiring and installation.

- Use a lighter for longer than the detection timer period within the detection area.
- Check the angle and size of area with the operation LED and connected transmitter.
- Check how the sensor operates around the edge of the detection area.
- If areas that do not need to be in the detection area are in the detection area, make adjustments by changing the angle or masking the area.
- Check the operation not only of the transmitter but also of the receiver.

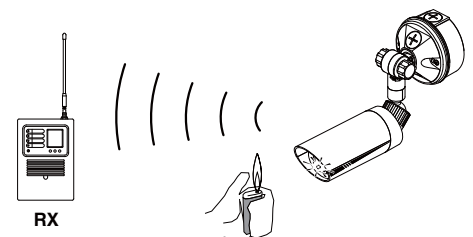

CAUTION

Do not use a lighter in a no fire zone because it is dangerous. If the sensor has been installed in a no fire zone, the operation test must be done in a different place with the use of only the sensor only.



8 FUNCTION SETTING

Detection Function

This product outputs an alarm when it detects ultraviolet rays emitted from flames. Outdoor installation causes much more false detection than is experienced with indoor installation, as there are many other sources of ultraviolet rays and few shielding objects. The 8 selectable sensitivity levels composed of 2 sensitivity settings and 4 detection timer settings have been included to prevent false detection in such uncertain conditions outdoors. Select the set up that most suits the environment and purpose. When the sensor issues unwanted alarms, set the sensitivity to "L" and the detection timer to the time setting that is the next longest to the present setting.

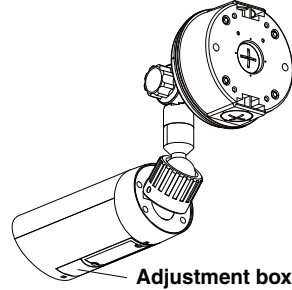
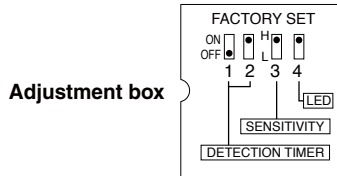

DETECTION TIMER

This function is used to set the minimum period of time it takes to generate an alarm from the time a flame is detected. An alarm is output when a flame continues to be detected for more than the set time. An alarm will not be issued if the flame is extinguished before the period of time set has elapsed.

The following 4 levels are selectable:

Switch 1, 2	DETECTION TIME	PURPOSE/EXAMPLE
OFF <input type="checkbox"/> OFF 1 2	1 sec	● Flame of lighter/match detection at non-smoking areas.
OFF <input type="checkbox"/> ON 1 2	6 sec	● FLAME OF N-HEPTANE [Factory set]
ON <input type="checkbox"/> OFF 1 2	15 sec	● If there is uncertainty about the above two levels, use this level.
ON <input type="checkbox"/> ON 1 2	30 sec	● Fire detection in uncertain environments.

SENSITIVITY

There are two steps that this function can be set according to the size of the detected flame. The sensitivity setting is chosen according to the size of the target flame because there is a correlation in the size of the flame and the detection area. The sensor's operation may be unstable when the setting is "H" if there is a continuously weak ultraviolet ray noise where the sensor is installed. Changing the setting to "L" is effective in the cancellation of such noise.

Switch 3	SENSITIVITY
H <input type="checkbox"/> 3	H: 100% [Factory set]
L <input type="checkbox"/> 3	L: 50%

* Assuming an identical flame, the detecting distance for "L" is half of the detecting distance for "H".

LED

Operatin LED disable

Switch 4	Lighting Operation
ON <input type="checkbox"/> 4	* Lighting is synchronized with detection * Use for operation check. [Factory set]
OFF <input type="checkbox"/> 4	Disable

* When the switch is ON,
The LED lights every time there is a detection.

- * When the sensor detects a weak ultraviolet ray, the warning may be delayed for longer than the time the timer is set at.
- * Intermittent ultraviolet rays that do not continue for as long as the set time will not cause the alarm to sound regardless of their strength.
- * When it is used outside, the recommended setting for the detection timer is 6 seconds or more.
- * When the operation is unstable and the cause is uncertain when you are using the sensor, set the sensitivity to "L" and readjust the current setting of the detection timer to one up, and then check the situation again.

9 TROUBLESHOOTING

Solve possible problems according to the following table:

If normal operations cannot be restored by these corrective actions, contact either the dealer from whom you bought the unit or TAKEX.

Trouble	Check	Corrective action
Completely inactive	<ul style="list-style-type: none"> ● No battery connected ● Low battery 	<ul style="list-style-type: none"> ● Connect battery ● Change battery
	<ul style="list-style-type: none"> ● No power supply (Broken wire or improper wire) 	<ul style="list-style-type: none"> ● Correct power supply or replace broken wire
	<ul style="list-style-type: none"> ● An object that is obstructing the rays is in front of detection area (Glass and transparent resin block ultraviolet rays) 	<ul style="list-style-type: none"> ● Remove the object obstructing the rays
	<ul style="list-style-type: none"> ● The interior of the sensor is wet due to condensation, etc. 	<ul style="list-style-type: none"> ● Dry out the sensor's interior, and remove the cause of the water ingress
Sometimes inactive	<ul style="list-style-type: none"> ● Improper area setting 	<ul style="list-style-type: none"> ● Readjust the sensor to an appropriate position
	<ul style="list-style-type: none"> ● Detection window has dust on it 	<ul style="list-style-type: none"> ● Remove the dust
	<ul style="list-style-type: none"> ● Low battery 	<ul style="list-style-type: none"> ● Change battery
Activated without flame	<ul style="list-style-type: none"> ● Large electrical noise source such as a radio station or high-voltage wire nearby 	<ul style="list-style-type: none"> ● Relocate the sensor
	<ul style="list-style-type: none"> ● Unexpected ultraviolet rays nearby (Ref : 3, PRECAUTIONS) 	<ul style="list-style-type: none"> ● Remove the source of the ultraviolet rays, the ultraviolet rays that are interrupting, or relocate the sensor
	<ul style="list-style-type: none"> ● The interior of the sensor is wet due to condensation, etc. 	<ul style="list-style-type: none"> ● Dry out sensor inside, and remove the cause of the wet

Maintenance

When the sensor is dirty clean the cover with a soft cloth moistened with a small amount of cleaning solution. Do not use chemicals such as thinners or alcohol. Check operation once a week. Do not fail to check operation whenever furniture in the vicinity is moved.

When the battery is low, change it for a new one immediately. If the battery is not changed, the sensor may not operate.

10 SPECIFICATIONS

Product Name		BATTERY OPERATED FLAME SENSOR
Model		TX-124R
Detection System		Ultraviolet rays detection (Detected wave length: 185 to 260nm)
Detection Area	Distance	33ft. (10m): (Gas Flame of Lighter in front of sensor: approx. : 2.75" (7cm)) 100ft. (30 m): (Flame of N-heptane on fire plate 15cm × 15cm: approx. : 23.62" (60cm)) *The flame size is rough.
	Angle	Vertical: approx. 75° (upward: 15°, downward: approx. 60°) Horizontal: approx. 100°
	Adjustment range	Vertical: downward 90° (horizontal-vertical) Horizontal: 180°
Sensitivity Adjustment	Sensitivity	H (100%), L (50%) [selectable by switch]
	Detection timer	1 sec, 6 sec, 15 sec, 30 sec [selectable by switch]
Supply Voltage		(Red/Black wires) DC3V (CR123A)
Current Consumption		Standby: 55µA Max, Detection: 1mA Max
Detection output		(Blue/White wires) Solid State Switch N.C 3VDC · 0.01A Max Output when detecting Ultraviolet, Real time + delay time 2 sec
Operation LED		Detection: Red LED Real time + delay time 2 sec
Ambient temperature		-4°F to +122°F (-20°C to 50°C)
Installation		Indoor, Outdoor
Weight		approx. 17.9 oz (510g)
Appearance		Resin (White)

11 EXTERNAL DIMENSIONS

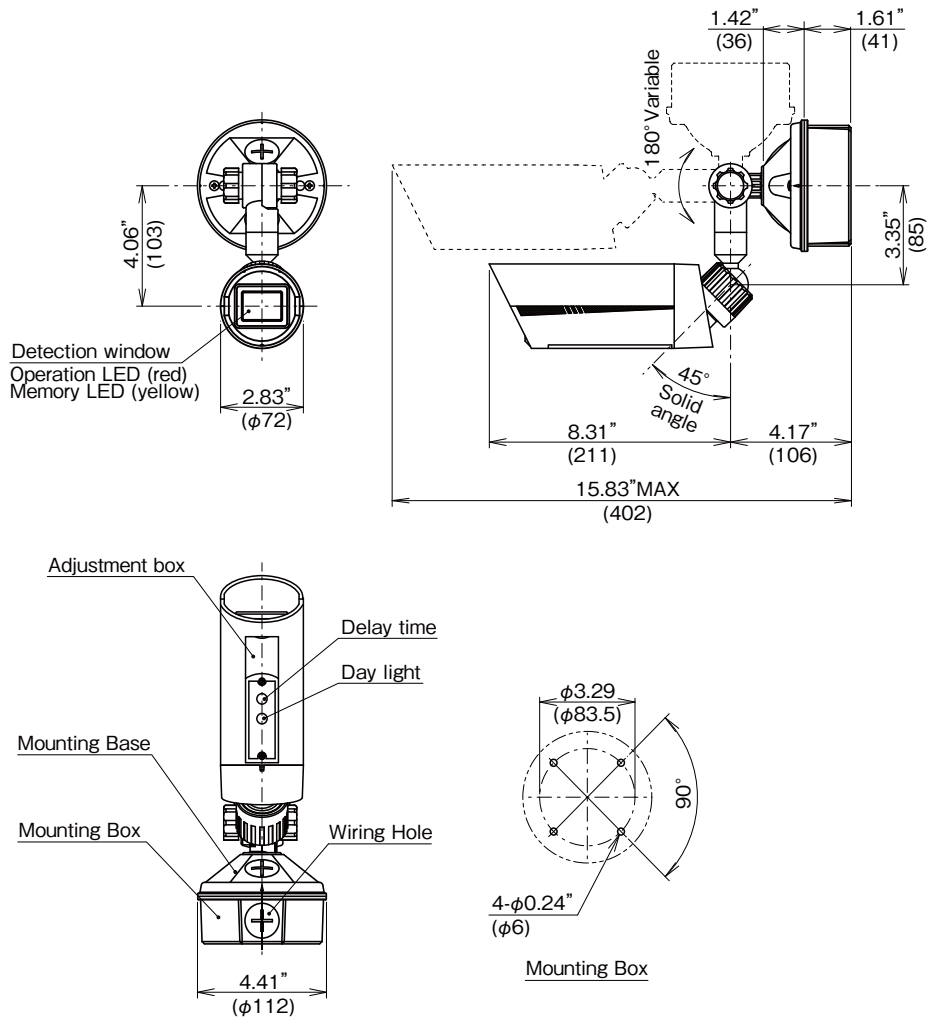

Limited Warranty :

TAKEX products are warranted to be free from defects in material and workmanship for 12 months from original date of shipment. Our warranty does not cover damage or failure caused by natural disasters, abuse, misuse, abnormal usage, faulty installation, improper maintenance or any repairs other than those provided by TAKEX. All implied warranties with respect to TAKEX, including implied warranties for merchantability and implied warranties for fitness, are limited in duration to 12 months from original date of shipment. During the Warranty Period, TAKEX will repair or replace, at its sole option, free of charge, any defective parts returned prepaid. Please provide the model number of the products, original date of shipment and nature of difficulty being experienced. There will be charges rendered for product repairs made after our Warranty Period has expired.

TAKEX TAKENAKA ENGINEERING CO., LTD.

In Japan
Takenaka Engineering Co., Ltd.
 83-1, Gojo-Dori, Sotokan Nishi-iru, Higashino,
 Yamashina-ku, Kyoto 607-8156, Japan
 Tel : 81-75-501-6651
 Fax : 81-75-593-3816
<https://www.takex-eng.co.jp/>

In the U.S.
Takex America Inc.
 151, San Zeno WAY
 Sunnyvale, CA 94086, USA
 Tel : 408-747-0100
 Fax : 408-734-1100
<https://www.takex.com>

In Australia
Takex America Inc.
 4/15 Howleys Road, Notting Hill,
 VIC, 3168
 Tel : +61 (03) 9544-2477
 Fax : +61 (03) 9543-2342
<https://www.takex.com>

In the U.K.
Takex Europe Ltd.
 Aviary Court, Wade Road,
 Basingstoke, Hampshire, RG24 8PE, U.K.
 Tel : (+44) 01256-475555
 Fax : (+44) 01256-466268
<https://www.takex.com>